



## STM8L101-EVAL demonstration firmware

---

### **1 Introduction**

This document describes the demonstration firmware running on the STM8L101-EVAL evaluation board. You can use it to evaluate the capabilities of the microcontroller and the on-board peripherals.

The evaluation board is delivered with the demonstration firmware stored in the Flash program memory of the microcontroller.

The firmware is based on the STM8L10x\_StdPeriph\_Lib firmware library, and provides an example of how to use this library. It is divided into various smaller demonstration applications (demos).

In case the evaluation board is not factory-programmed or the demonstration application has been erased, you can reprogram the demonstration firmware into the STM8L10x Flash memory by referring to `stm8l10x-eval_fw_um.chm` file available in the STM8L1x-EVAL\_FW package.

For more information about the evaluation board itself, please read the evaluation board user manual.

*Note: To run the demonstration firmware, JP10 jumper must be installed on the STM8L101-EVAL evaluation board.*

# Contents

- 1 Introduction ..... 1**
- 2 User interface ..... 3**
  - 2.1 Menu structure ..... 3
  - 2.2 Documentation conventions ..... 3
  - 2.3 Navigating menus and sub-menus ..... 4
- 3 Demonstration applications ..... 5**
  - 3.1 Menu overview ..... 5
  - 3.2 Welcome screen and main menu ..... 5
  - 3.3 Help mode ..... 5
  - 3.4 PWM demo ..... 6
  - 3.5 BEEPER demo ..... 7
  - 3.6 MICROSD demo ..... 8
  - 3.7 About menu ..... 9
- 4 STM8L10x peripherals used ..... 10**
- 5 Demo firmware architecture ..... 11**
- 6 Revision history ..... 12**

## 2 User interface

### 2.1 Menu structure

The demonstration firmware user interface is based on a circular navigation menu, with submenus, item selection and back capability.

*Figure 1* shows the menu system of the demonstration. The top row of items represents the main menu.

**Figure 1. Menu structure and navigation**

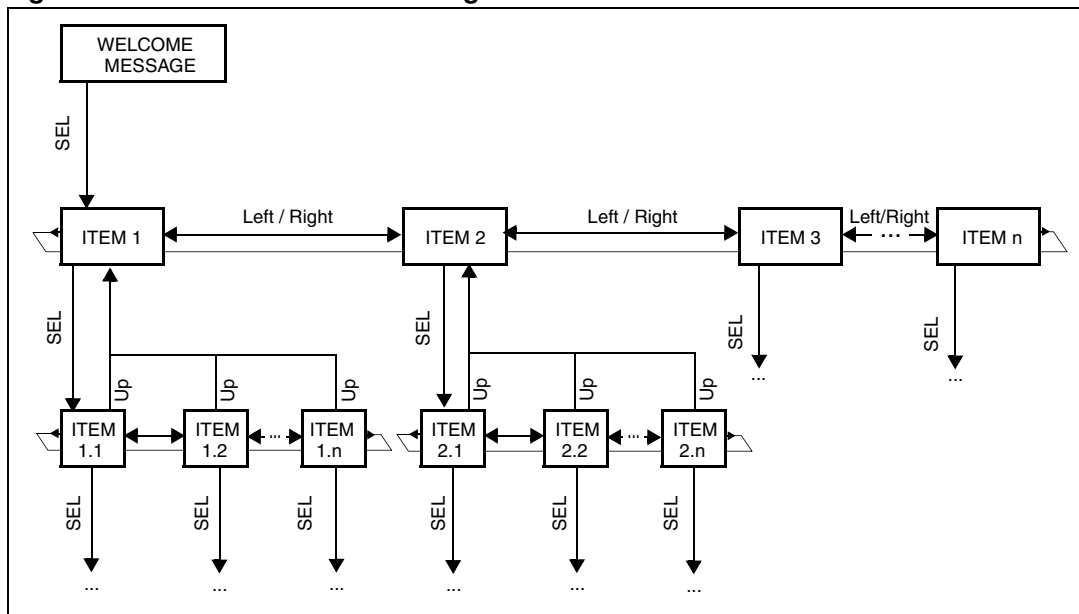

### 2.2 Documentation conventions

In this document, the keywords in bold indicate user actions on the joystick (5-way switch), and on the KEY button (1-way switch). They follow the conventions shown in *Table 1*.

**Table 1. Documentation conventions**

Keyword	User action
<b>LEFT</b>	Press joystick to the left
<b>RIGHT</b>	Press joystick to the right
<b>UP</b>	Press joystick up
<b>DOWN</b>	Press joystick down
<b>SEL</b>	Press joystick center
<b>KEY</b>	Press KEY button

## 2.3 Navigating menus and sub-menus

To navigate the menus and sub-menus, perform the following actions as required:

**RIGHT:** Navigates to the next menu or sub-menu items on the right.

**LEFT:** Navigates to the next menu or sub-menu items on the left.

**SEL:** Enters sub-menu.

**UP:** Exits from a sub-menu.

## 3 Demonstration applications

### 3.1 Menu overview

The [Figure 2](#) shows all the menu and submenus of the demonstration applications.

**Figure 2. Menu overview**

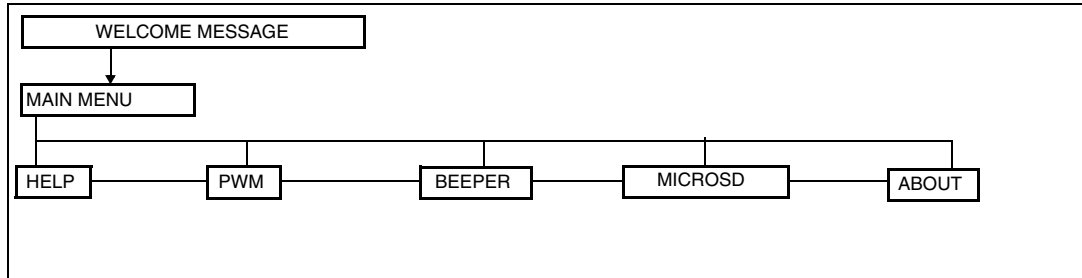

The following sections provide a detailed description of each part of the demonstration firmware.

### 3.2 Welcome screen and main menu

After a board RESET, a welcome message is displayed on the first line, the ST logo is displayed moving on the second line and a melody is played (see [Figure 3](#)). The introduction melody can be changed by using the PWM demo (see [Section 3.4](#)).

**Figure 3. Welcome message**

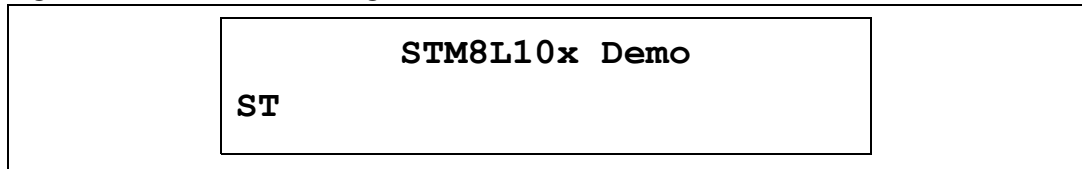

Once the melody is played, the main menu is activated and the message shown in [Figure 4](#) is displayed:

**Figure 4. Main menu**

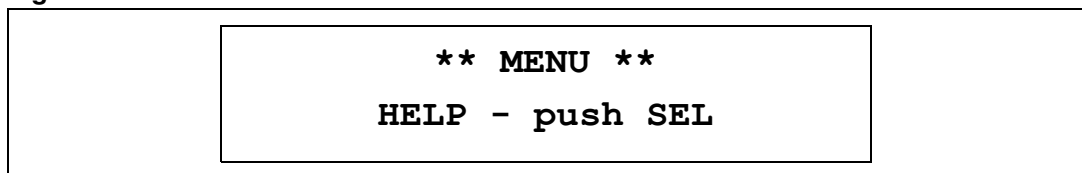

*Note:* Pressing the joystick in any direction (for around 1 second) ends the melody.

### 3.3 Help mode

Pressing **SEL** from the main menu enters the *Help* mode. The following messages are displayed sequentially on the LCD screen with a few second delay:

**Figure 5. Help mode submenus**

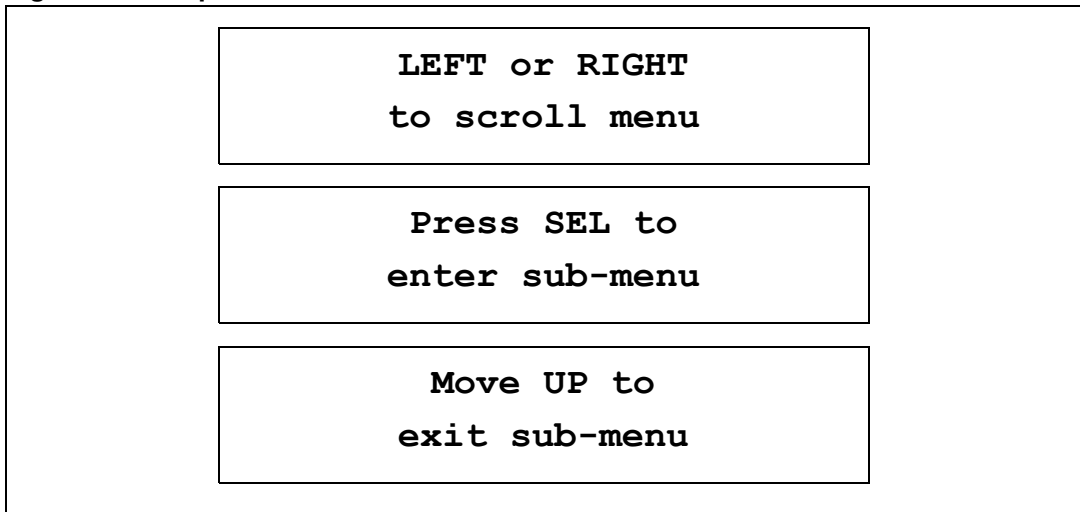

To exit this demo, press the joystick **UP**.

### 3.4 PWM demo

This mode demonstrates the Timer peripheral operating in PWM mode. Make sure that the JP9 jumper is installed in the PSW position.

This demo is used to select and play one melody among a selection stored in the Flash memory (see [Figure 6](#)):

1. Navigate between the melodies by pressing the joystick **LEFT** or **RIGHT**, and press **SEL** to select and play the melody (see [Figure 6](#))

**Figure 6. Selecting a melody**

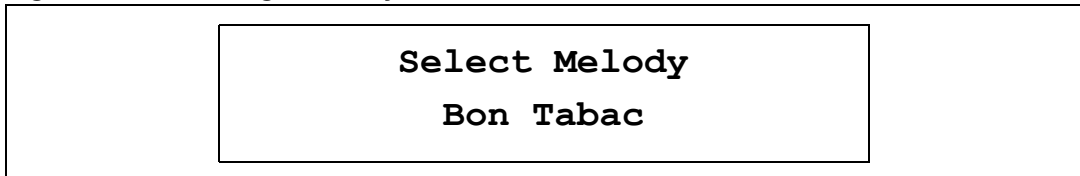

2. The first time **UP** is pressed, the melody is stopped.

*Note:* Keep the joystick pressed **UP** for a short time to allow the action to be taken into account.

3. If you press **UP**, you exit from the demo.

**LEFT/RIGHT:** Press the joystick **LEFT** or **RIGHT** to navigate the melodies.

**SEL:** Press **SEL** to select a melody and play it.

### 3.5 BEEPER demo

This mode demonstrates the 3 different frequencies that can be output on the BEEP pin. Prior to running the BEEPER demo,

- Install the JP9 jumper in the Beep position.
- Exit the Debug session since the BEEPER demo can be run only in standalone mode.

When this mode is entered, the LSI clock is calibrated by TIM2.

The message shown in [Figure 7](#) is displayed at the end of calibration:

**Figure 7. End of calibration message**

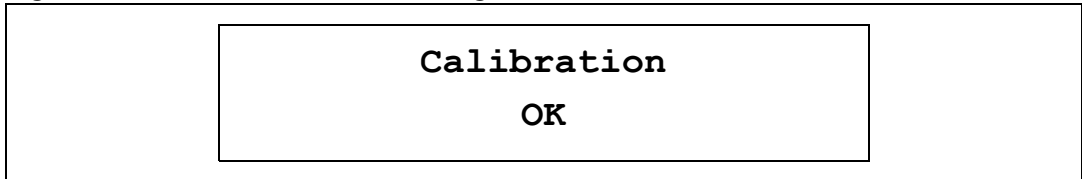

After a short time, another message shows the current output frequency.

Press the **KEY** button repeatedly to change the frequency in this order:

- 1 kHz
- 2 kHz
- 4 kHz
- 1-2-4 kHz
- OFF
- 1 kHz etc...

The frequency selected is displayed on the LCD screen (see [Figure 8](#))

The LEDs also change depending on the selected frequency.

**Figure 8. Selecting the beep frequency**

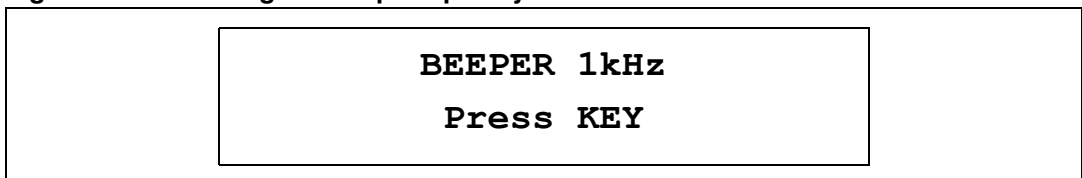

**UP:** Press the joystick **UP** to exit the demo.

**KEY:** Press the **KEY** button to change the beeper frequency.

### 3.6 MICROSD demo

This mode demonstrates the basic operation of the MicroSD card interface.

1. When this mode is entered, a MicroSD card must be inserted in the slot.
  - The message shown in [Figure 9](#) is displayed on the LCD screen:

**Figure 9. No card found**

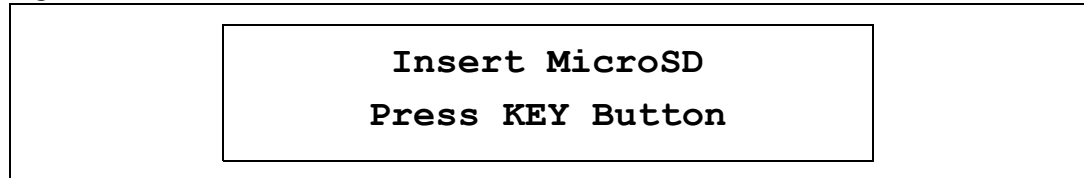

- When a MicroSD card is detected, another message is displayed (see [Figure 10](#)):

**Figure 10. Card detected**

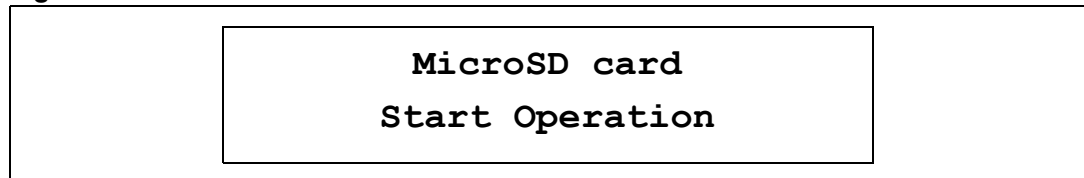

2. Then the MicroSD card is initialized, followed by a Write block (512 bytes) and a Read block operation. See [Figure 11](#) for the messages displayed consecutively on the LCD screen:

**Figure 11. MicroSD card initialization**

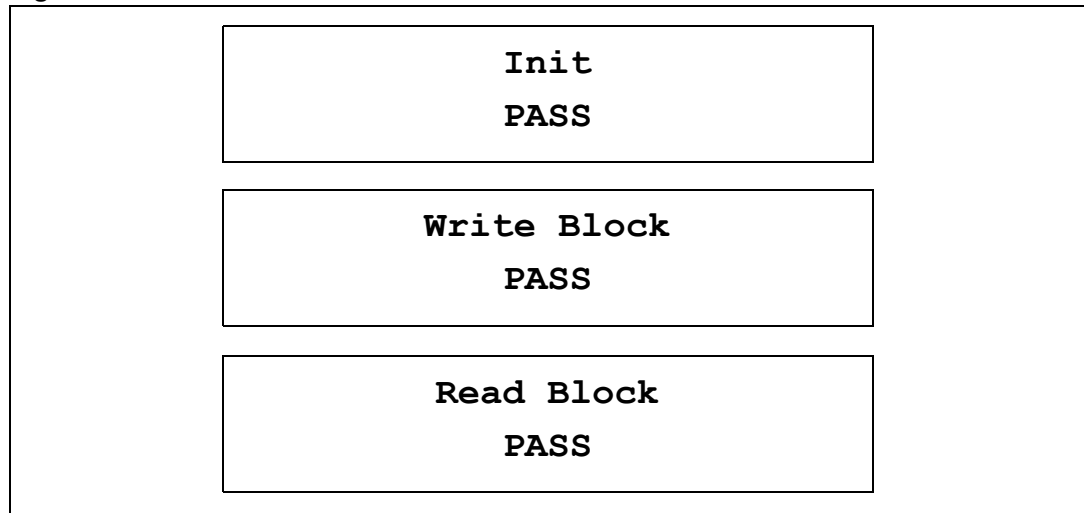

3. When this phase is complete, the message shown in [Figure 12](#) is displayed. By pressing the joystick to **LEFT** or **RIGHT**, the MicroSD card is read, and the string 'DEMO MICROSD' is displayed on the LCD screen, one character at a time.

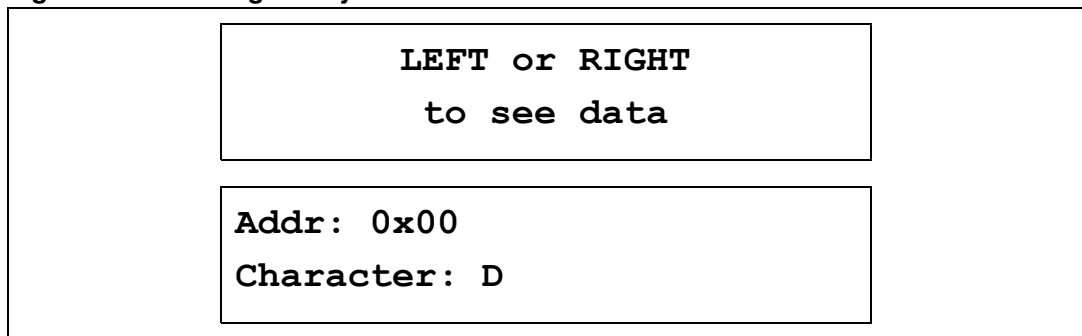

**Figure 12. Reading 512 bytes from the MicroSD card**

### 3.7 About menu

This menu shows the firmware version. When this submenu is selected the message shown in [Figure 13](#) is displayed on the LCD screen:

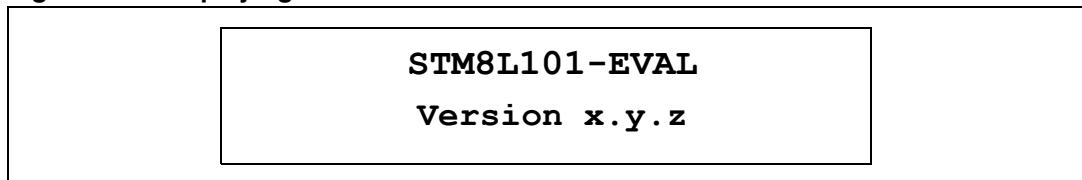
**Figure 13. Displaying the demonstration firmware version**

**UP:** Press the joystick **UP** to exit this menu.

## 4 STM8L10x peripherals used

The following table lists the STM8L10x peripherals used in each demo:

**Table 2. Peripherals used**

Peripheral	Demo
GPIO	All demos (buttons, LEDs)
Clock Controller	All demos
BEEPER	Beeper demo
SPI	All demos (LCD + MicroSD)
TIM2	LSI Calibration
TIM3	PWM demos (Buzzer)
TIM4	All demos (time base)

## 5 Demo firmware architecture

This section describes the demo firmware architecture. It is divided into two parts:

- **Library:** contains the firmware library source files. These files do not need to be modified by the user.
- **Application:** contains the specific files of the demonstration firmware that can be modified:
  - *stm8l10x\_conf.h*: this header file is used to configure the library
  - *stm8l10x\_it.h*: header for the *stm8l10x\_it.c* file
  - *stm8l10x\_it.c*: this file provides all the interrupt sub-routines
  - *stm8\_interrupt\_vector.c*: this file provides the interrupt vector table
  - *demo\_xxx.h*: header for the *demo\_xxx.c* file
  - *demo\_xxx.c*: this file provides all functions related to the xxx demo
  - *functions.h*: header for the *functions.c* file
  - *functions.c*: this file provides miscellaneous functions.
  - *joystick\_button.h*: header for the *joystick\_button.c* file
  - *joystick\_button.c*: this file provides all functions related to the management of the joystick and button
  - *mono\_lcd.h*: header for the *mono\_lcd.c* file
  - *mono\_lcd.c*: this file provides LCD management functions
  - *main.h*: header for the *main.c* file
  - *main.c*: this file provides the main function
  - *menu.h*: header for the *menu.c* file
  - *menu.c*: this file provides menu functions and menu definition

## 6 Revision history

**Table 3. Document revision history**

Date	Revision	Changes
17-Apr-2009	1	Initial release.

**Please Read Carefully:**

Information in this document is provided solely in connection with ST products. STMicroelectronics NV and its subsidiaries ("ST") reserve the right to make changes, corrections, modifications or improvements, to this document, and the products and services described herein at any time, without notice.

All ST products are sold pursuant to ST's terms and conditions of sale.

Purchasers are solely responsible for the choice, selection and use of the ST products and services described herein, and ST assumes no liability whatsoever relating to the choice, selection or use of the ST products and services described herein.

No license, express or implied, by estoppel or otherwise, to any intellectual property rights is granted under this document. If any part of this document refers to any third party products or services it shall not be deemed a license grant by ST for the use of such third party products or services, or any intellectual property contained therein or considered as a warranty covering the use in any manner whatsoever of such third party products or services or any intellectual property contained therein.

**UNLESS OTHERWISE SET FORTH IN ST'S TERMS AND CONDITIONS OF SALE ST DISCLAIMS ANY EXPRESS OR IMPLIED WARRANTY WITH RESPECT TO THE USE AND/OR SALE OF ST PRODUCTS INCLUDING WITHOUT LIMITATION IMPLIED WARRANTIES OF MERCHANTABILITY, FITNESS FOR A PARTICULAR PURPOSE (AND THEIR EQUIVALENTS UNDER THE LAWS OF ANY JURISDICTION), OR INFRINGEMENT OF ANY PATENT, COPYRIGHT OR OTHER INTELLECTUAL PROPERTY RIGHT.**

**UNLESS EXPRESSLY APPROVED IN WRITING BY AN AUTHORIZED ST REPRESENTATIVE, ST PRODUCTS ARE NOT RECOMMENDED, AUTHORIZED OR WARRANTED FOR USE IN MILITARY, AIR CRAFT, SPACE, LIFE SAVING, OR LIFE SUSTAINING APPLICATIONS, NOR IN PRODUCTS OR SYSTEMS WHERE FAILURE OR MALFUNCTION MAY RESULT IN PERSONAL INJURY, DEATH, OR SEVERE PROPERTY OR ENVIRONMENTAL DAMAGE. ST PRODUCTS WHICH ARE NOT SPECIFIED AS "AUTOMOTIVE GRADE" MAY ONLY BE USED IN AUTOMOTIVE APPLICATIONS AT USER'S OWN RISK.**

Resale of ST products with provisions different from the statements and/or technical features set forth in this document shall immediately void any warranty granted by ST for the ST product or service described herein and shall not create or extend in any manner whatsoever, any liability of ST.

ST and the ST logo are trademarks or registered trademarks of ST in various countries.

Information in this document supersedes and replaces all information previously supplied.

The ST logo is a registered trademark of STMicroelectronics. All other names are the property of their respective owners.

© 2009 STMicroelectronics - All rights reserved

STMicroelectronics group of companies

Australia - Belgium - Brazil - Canada - China - Czech Republic - Finland - France - Germany - Hong Kong - India - Israel - Italy - Japan - Malaysia - Malta - Morocco - Philippines - Singapore - Spain - Sweden - Switzerland - United Kingdom - United States of America

[www.st.com](http://www.st.com)

