

Rad-hard 40 V, 3 A Schottky rectifier in SOD128Flat package

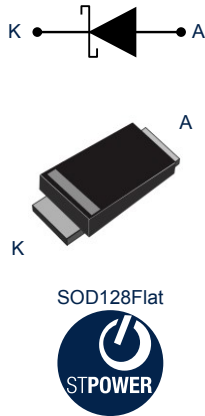

Features

- Max. reverse voltage = 40 V
- Average on state current = 3 A
- Max. junction temperature = 150 °C
- DC thermal resistance $R_{TH(JL)}$ = 10 °C/W
- ESCC qualified diode die
- SOD128Flat surface mount package
- Reliability qualification based on AEC-Q101
- Tiny package : 2.5 x 4.8 = 12 mm²
- Fast switching and low on-state voltage
- Radiation tested performances:
 - TID 300 krad(Si) at high dose rate
 - TNID 3.10¹¹ particles/cm²
 - SEB free at full V_{RWM} up to 60 MeV.cm²/mg

Product status link

[LEO1N5822](#)

Product summary

$I_{F(AV)}$	3 A
V_{RRM}	40 V
$V_F(\text{max.})$ at 125°C and $I_{F(AV)}$	0.39 V
$T_J(\text{max.})$	150 °C

Applications

- Low earth orbit (LEO) space applications
- Satellite constellation
- High reliability systems
- Output high frequency rectification
- Free-wheeling diode
- Converter Or-ring
- Reverse polarity protection

Description

The 3 A, 40 V Schottky diode [LEO1N5822](#) is a rad-hard rectifier housed in the tiny surface-mount SOD128Flat package, operating with a junction temperature from -40 °C to +150 °C.

The [LEO1N5822](#) meets the challenges of the LEO satellites for performance and reliability in a strict budget thanks to the STMicroelectronics LEO generic specification dedicated to space ready rad-hard plastic power discretes; this AEC-Q101-based specification offers a trade-off among foot-print size savings and cost of ownership together with radiation hardness and large production capacity.

The [LEO1N5822](#) rectifier is suitable for switching mode power supplies and high frequency DC-to-DC converters such as low voltage high frequency inverter, OR-ring, free-wheeling, blocking diode or reverse polarity protection. It is well suited for critical mission equipment such as avionics and Hi-Rel industrial.

1 Characteristics

Table 1. Absolute ratings (limiting values at $T_j = 25\text{ °C}$, unless otherwise specified)

Symbol	Parameter	Value	Unit
V_{RRM}	Repetitive peak reverse voltage	$T_j = -40\text{ °C to }150\text{ °C}$	40 V
$V_{RWM}^{(1)}$	Working peak reverse voltage	$T_j = -40\text{ °C to }150\text{ °C}$	40 V
$I_{F(AV)}$	Average forward current, square waveform	$T_L = 125\text{ °C}, \delta = 0.5^{(2)}$	3 A
I_{FSM}	Non repetitive surge forward current	$t_p = 8.3\text{ ms sinusoidal}$	137 A
		$t_p = 10\text{ ms sinusoidal}$	130 A
T_{stg}	Storage temperature range	-65 to +150	°C
T_j	Junction temperature range	-40 to +150	°C
T_{sol}	Maximum soldering lead temperature, for less than 10 s time. ⁽³⁾	260	°C
ESD	Electro static discharge, HBM model	8	kV

1. See [Figure 1](#).
2. δ = duty cycle and T_L = Lead temperature
3. Refer to application note [AN5088](#) for soldering and mounting recommendations.

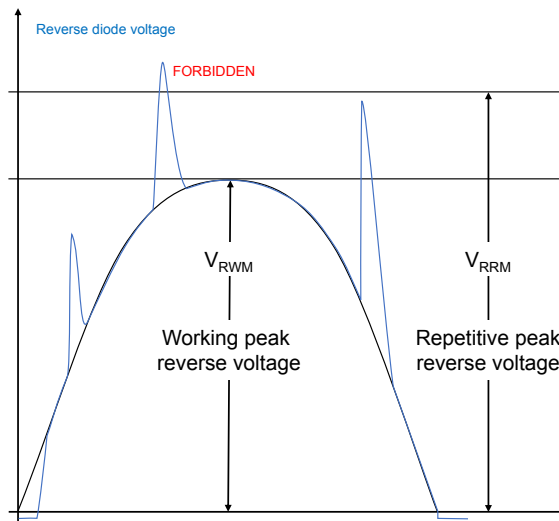
Figure 1. V_{RRM} and V_{RWM} definition with their waveform

Table 2. Thermal parameters

Symbol	Parameter	Typ.	Max.	Unit
$R_{th(j-l)}$	Junction to lead	10	15	°C/W

For more information, refer to the application note:

- [AN5088: Rectifiers thermal management, handling and mounting recommendation](#)

Table 3. Static electrical characteristics

Symbol	Parameter	Test conditions		Typ.	Max.	Unit
$I_R^{(1)}$	Reverse leakage current	$T_j = -40\text{ °C}$	$V_R = V_{RRM}$		40	μA
		$T_j = 25\text{ °C}$			80	
		$T_j = 125\text{ °C}$			40	mA
$V_F^{(2)}$	Forward voltage drop	$T_j = 25\text{ °C}$	$I_F = 1\text{ A}$		0.4	V
		$T_j = 125\text{ °C}$		0.23	0.28	
		$T_j = 25\text{ °C}$	$I_F = 3\text{ A}$		0.485	
		$T_j = 125\text{ °C}$		0.33	0.39	
		$T_j = 25\text{ °C}$	$I_F = 9.4\text{ A}$		0.7	
		$T_j = 125\text{ °C}$		0.52	0.61	

1. Pulse test: $t_p = 5\text{ ms}$, $\delta < 2\%$, $\delta = \text{duty cycle}$

2. Pulse test: $t_p = 680\text{ }\mu\text{s}$, $\delta < 2\%$

To evaluate the conduction losses, use the following equation:

$$P = 0.25 \times I_{F(AV)} + 0.047 \times I_F^2 (RMS)$$

For more information, refer to the following application notes related to the power losses:

- [AN604](#): Calculation of conduction losses in a power rectifier

Table 4. Dynamic characteristics

Symbol	Parameter	Test conditions	Test conditions	Max.	Unit
C_j	Total diode capacitance	$V_R = 5\text{ V}$, $F = 1\text{ MHz}$	$T_j = 25\text{ °C}$	240	pF

2 Radiation

The Schottky diodes are intrinsically resistant to radiative environments in TID as described in the ECSS-Q-ST-60-15C1 radiation hardness assurance standard.

The STMicroelectronics LEO1N5822 goes beyond the standard and is characterized in total ionization dose test at high dose rates (TID), single effect event (SEE), and total non-ionization dose (TNID), as described below.

Total Ionization Dose (TID)

The TID characterization is done for the product qualification in compliance with the ESCC 22900 specification. It is performed at 620 krad(Si)/h high dose rate (HDR), thus on 15 samples, 5 reverse biased, 5 samples forward biased, and 5 samples unbiased for each dose rate.

The electrical parameters of Table 3 are measured at both pre- and post-irradiation using the same circuitry and the same test conditions for a comparison of their drifts.

Total Non-Ionization Dose (TNID)

The TNID characterization is done for the product qualification in compliance with the ESCC 22500 specification up to $6 \cdot 10^{11}$ protons/cm² with 50 MeV proton charge energy. The electrical parameters of Table 3 are tested before and after the radiation test using the same circuitry and the same test conditions for a direct comparison ($T_{AMB} = 22 \pm 3$ °C). The TNID test is included in each wafer lot acceptance test and is specified at $3 \cdot 10^{11}$ protons/cm².

Single Event Effect (SEE)

The SEE characterization is performed for the product qualification in compliance with the ESCC 25100 specification at room temperature on 3 pieces from one wafer and in accordance with the LEO specification up to 60 MeV.cm²/mg.

The test conditions and acceptance criteria are described below:

- SEB test (destructive mode):
 - The diode is reverse biased during irradiation. The test is stopped as soon as a SEB occurs or when the reverse leakage current is above the specification or when the overall fluence on the component reaches 10^7 heavy ions/cm².
- PIST test:
 - After the irradiation, a voltage stress is applied to the irradiated diode revealing any latent damage. The reverse voltage is increased from 0 V to 100 % of V_{RRM} and then decreased back to 0 V. At each step, the reverse leakage current value is measured.

Table 5. Radiations performance table

Symbol	Characteristics	Value
TID	As per ESCC 22900, high dose rate temperature = 22 ± 3 °C, performed on 5 parts	Within Table 3 up to 300 krad(Si)
TNID	As per ESCC 22500, temperature = 22 ± 3 °C, performed on 5 parts per wafer lot	Within Table 3 up to 3×10^{11} p/cm ²
SEB	As per ESCC 25100, temperature = 22 ± 3 °C, fluence: 10^7 ions/cm ² , performed on 5 parts	Within Table 3 up to 60 MeV/cm ² /mg

A total ionizing dose TID of 300 krad(Si) is equivalent to 3000 Gy(Si), (1 gray = 100 rad).
SEB stands for single event burnout.

3 Outgassing

The molding resin of the SOD128Flat package is characterized as per ASTM E595 specification. Its recovered mass loss (RML) and collected volatile condensable material (CVCM) are provided in [Table 6. Outgassing performance of the molding resin of the SOD128Flat package](#). It complies with the ST generic specification LEO listed here below:

- Recovered mass loss RML < 1 %
- Collected volatile condensable material CVCM < 0.1 before irradiation

Table 6. Outgassing performance of the molding resin of the SOD128Flat package

Specification (tested per ASTM E595)	Value	Units
Recover mass loss RML ⁽¹⁾	TBD	%
Collected volatile condensable material CVCM ⁽²⁾	TBD	%

1. LEO specification requirement: RML < 1 %.
2. LEO specification requirement: CVCM < 0.1 %

4 Package information

To meet environmental requirements, ST offers these devices in different grades of **ECOPACK** packages, depending on their level of environmental compliance. ECOPACK specifications, grade definitions, and product status are available at: www.st.com. ECOPACK is an ST trademark.

4.1 SOD128Flat package information

The SOD128Flat package is made of a halogen free molding compound resin. This resin meets the flammability standard, UL94 level V0. It is graded MSL1 as per JSTD-020 moisture sensitivity.

The diode die is connected to the terminal leads with a copper clip for a high surge current rating. Its leads are 100 % matte-Sn plated and meet JESD 201 whisker test class 2.

Figure 2. SOD128Flat package outline

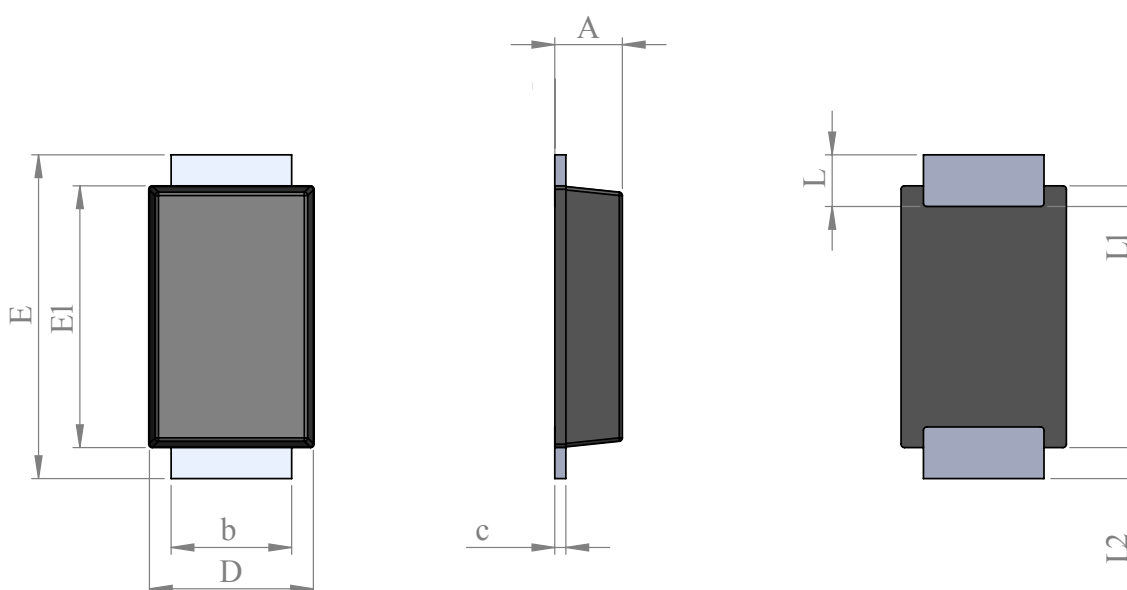

Note: This package drawing may slightly differ from the physical package. However, all the specified dimensions are ensured in millimeters.

Table 7. SOD128Flat package mechanical data

Ref.	Dimensions			
	Millimeters		Inches ⁽¹⁾	
	Min.	Max.	Min.	Max.
A	0.93	1.03	0.037	0.041
b	1.69	1.81	0.067	0.071
c	0.10	0.22	0.004	0.009
D	2.30	2.50	0.091	0.098
E	4.60	4.80	0.181	0.189
E1	3.70	3.90	0.146	0.154
L	0.55	0.85	0.026	0.033
L1	0.30 typ.		0.012 typ.	
L2	0.45 typ.		0.018 typ.	

1. Inches values are indicative.

Figure 3. IPC recommended SOD128Flat footprint density level B in mm (inches)

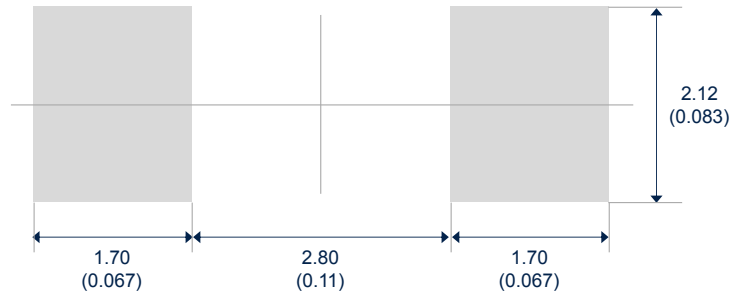

5 Ordering information

Table 8. Ordering information

Order code	Quality level	Package	Lead finishing	Product marking	Mass	Base qty.	Packing
LEO1N5822AF1	Development sample	SOD128Flat	Matte Tin	TBD	26.4 mg	TBD	Partial reel
LEO1N5822AF	Flight model			5822L		500	Full reel

The development samples are identical to the flight model products to the exception of the minimum base quantity and the available documentation as per [Section 6.3: Documentation](#).

6 Other information

6.1 Product marking description

Figure 4. Product marking outline

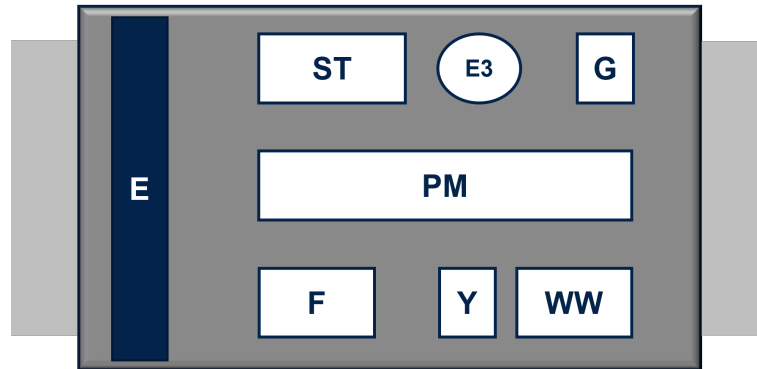

Table 9. Product marking description

Field	Description
E3	Pb free logo
ST	ST logo
G	Eco level, G
PM	Product marking
E	Cathode mark band
F	Assembly location code
Y	Assembly year last digit
WW	Assembly week two-digit index

6.2 Packing information

The LEO1N5822 is provided in 500 pieces tape and reel. Its reel dimensions are described below.

Figure 5. SOD128Flat carrier tape outline, bottom view (not in scale)

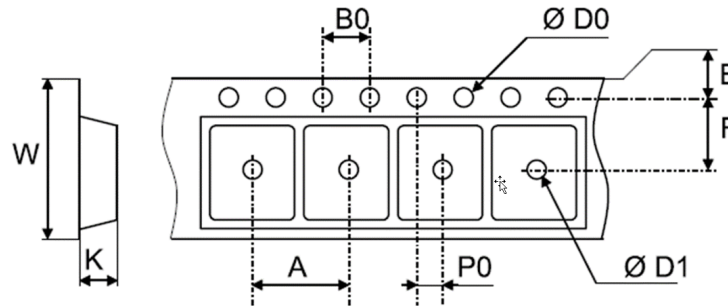
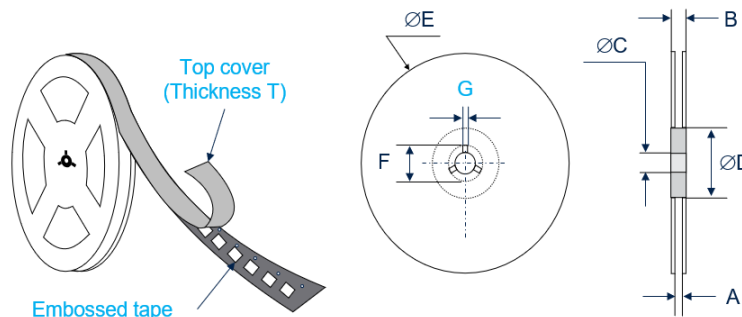

Table 10. SOD128Flat tape carrier dimension data

Carrier tape typical dimension data							
A	B0	D0	D1	F	K	P0	W
4 ±0.1	4 ±0.1	1.5 ±0.1	1.55 ±0.05	5.5 ±0.05	1.25 ±0.05	2 ±0.05	12 ±0.2

Figure 6. SOD128Flat tape-and-reel outline with package orientation and feed direction (not in scale)



Package orientation and feed direction

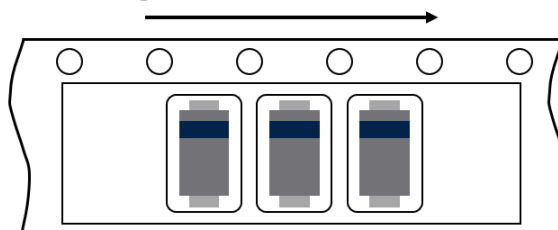

Table 11. SOD128Flat reel dimension data

Base qty.	Reel dimension (mm)							
	A	B(max.)	C	D(min.)	E(max.)	F(min.)	G	T(max.)
500	12.4 ±0.5	18.4	13.2 +0.5/-0.2	60 ±0.5	330	20.2	2 ±0.5	0.10

6.3 Documentation

In Table 12 is listed a summary of the documentation referring to each the flight model product delivery. This documentation is listed on printed paper in a dedicated envelope.

Table 12. Documentation provided for each type of product

Quality level	Documentation
Design model	Production datasheet, available on ST Web
Flight model	Certificate of conformance including : <ul style="list-style-type: none"> • Customer name • Customer purchase order number • ST order confirmation number • ST part number • Product marking • Delivered quantity • Product date code • Wafer lot number and manufacturing location • Detail specification – Product datasheet • Generic specification reference • Radiation validation test RVT report reference • Wafer lot acceptance report references, including: <ul style="list-style-type: none"> – Assembly statistical process control SPC report – Wafer lot characterization report – Wafer lot reliability report

Lot acceptance test (LAT)

A lot acceptance test is achieved for each produced wafer diffusion lot: It includes at least a TNID radiation test and a high temperature reverse bias reliability test (HTRB) and is referenced in the certificate of compliance of the delivered order.

Revision history

Table 13. Document revision history

Date	Revision	Changes
22-Oct-2024	1	Initial release.

Contents

1	Characteristics	2
2	Radiation	4
3	Outgassing	5
4	Package information	6
4.1	SOD128Flat package information	6
5	Ordering information	8
6	Other information	9
6.1	Product marking description	9
6.2	Packing information	10
6.3	Documentation	11
	Revision history	12

IMPORTANT NOTICE – READ CAREFULLY

STMicroelectronics NV and its subsidiaries (“ST”) reserve the right to make changes, corrections, enhancements, modifications, and improvements to ST products and/or to this document at any time without notice. Purchasers should obtain the latest relevant information on ST products before placing orders. ST products are sold pursuant to ST’s terms and conditions of sale in place at the time of order acknowledgment.

Purchasers are solely responsible for the choice, selection, and use of ST products and ST assumes no liability for application assistance or the design of purchasers’ products.

No license, express or implied, to any intellectual property right is granted by ST herein.

Resale of ST products with provisions different from the information set forth herein shall void any warranty granted by ST for such product.

ST and the ST logo are trademarks of ST. For additional information about ST trademarks, refer to www.st.com/trademarks. All other product or service names are the property of their respective owners.

Information in this document supersedes and replaces information previously supplied in any prior versions of this document.

© 2024 STMicroelectronics – All rights reserved