

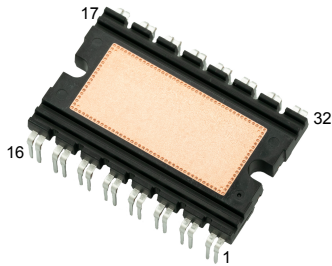

Automotive-grade ACEPACK DMT-32 power module, fourpack topology, 1200 V, 78 mΩ typ. SiC Power MOSFET with NTC



ACEPACK DMT-32

Features

- AQG 324 qualified 
- 1200 V blocking voltage
- 78 mΩ of typical $R_{DS(on)}$
- Maximum operating junction temperature $T_J = 175\text{ °C}$
- DBC Cu-AlN-Cu based substrate to improve thermal performance
- Isolation voltage 3 kV
- Integrated NTC temperature sensor

Applications

- On board charger (OBC)

Description

This ACEPACK DMT-32 power module realizes a fourpack topology with integrated NTC, tailored for DC/DC converter stage of the OBC in hybrid and electric vehicles. The power module features four silicon carbide Power MOSFETs of 2nd generation from STMicroelectronics. Thanks to the well-recognized chip technology, the ACEPACK DMT-32 ensures the best compromise between energy losses and high switching frequency operation mode. This module allows you to create complex topologies with very high power densities as well as high efficiency requirements. The AlN insulated substrate enables optimal thermal performance. Moreover, thanks to the specific design featuring grooves on the molding ensure a high creepage distance.

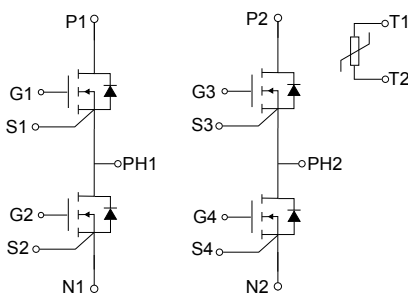

Product status link

[M1F80M12W2-1LA](#)

Product summary

Order code	M1F80M12W2-1LA
Marking	M1F80M12W2-1LA
Package	ACEPACK DMT-32
Packing	Tube

1 Inverter switch

Table 1. Absolute maximum ratings

Symbol	Parameter	Value	Unit
V_{DS}	Drain-source breakdown voltage	1200	V
V_{GS}	Gate-source voltage	-10 to 22	V
	Gate-source voltage (recommended operating values)	-5 to 18	
I_D	Drain current (continuous) at $T_C = 50\text{ °C}$	30	A
$I_{DM}^{(1)}$	Drain current (pulsed, $t_p = 1\text{ ms}$)	54	A
T_J	Operating junction temperature range	-40 to 175	°C

1. Pulse width is limited by safe operating area.

Table 2. Electrical characteristics - SiC MOSFET

Symbol	Parameter	Test conditions	Min.	Typ.	Max.	Unit
$R_{DS(on)}$	Static drain-source on resistance	$V_{GS} = 18\text{ V}, I_D = 20\text{ A}$		78	108	mΩ
		$V_{GS} = 18\text{ V}, I_D = 20\text{ A}, T_J = 175\text{ °C}$		175.5		
$V_{GS(th)}$	Gate threshold voltage	$V_{DS} = V_{GS}, I_D = 1\text{ mA}$	1.9	3.2	5	V
I_{DSS}	Zero gate voltage drain current	$V_{GS} = 0\text{ V}, V_{DS} = 1200\text{ V}$			10	μA
I_{GSS}	Gate-body leakage current	$V_{DS} = 0\text{ V}, V_{GS} = -10\text{ to }22\text{ V}$			±100	nA
C_{iss}	Input capacitance	$V_{DS} = 800\text{ V}, f = 1\text{ MHz}, V_{GS} = 0\text{ V}$		1230		pF
C_{oss}	Output capacitance			56		pF
C_{rss}	Reverse transfer capacitance			15		pF
R_G	Intrinsic gate resistance	$f = 1\text{ MHz open drain}$		1		Ω
Q_g	Total gate charge	$V_{DD} = 800\text{ V}, I_D = 20\text{ A},$ $V_{GS} = -5\text{ to }18\text{ V}$		63		nC
Q_{gs}	Gate-source charge			15		nC
Q_{gd}	Gate-drain charge			20		nC
E_{on}	Turn-on switching energy	$V_{DS} = 800\text{ V}, I_D = 20\text{ A}, V_{GS} = -5\text{ to }18\text{ V},$ $R_{G(on)} = 8.2\text{ Ω}, R_{G(off)} = 3.3\text{ Ω}$		304		μJ
E_{off}	Turn-off switching energy			64		μJ
E_{on}	Turn-on switching energy	$V_{DS} = 800\text{ V}, I_D = 20\text{ A}, V_{GS} = -5\text{ to }18\text{ V},$ $R_{G(on)} = 8.2\text{ Ω}, R_{G(off)} = 3.3\text{ Ω},$ $T_J = 175\text{ °C}$		509		μJ
E_{off}	Turn-off switching energy			65		μJ
R_{thJC}	Thermal resistance, junction-to-case			0.59		°C/W

Table 3. Reverse intrinsic SiC diode characteristics

Symbol	Parameter	Test conditions	Min.	Typ.	Max.	Unit
V_{SD}	Forward on voltage drop	$V_{GS} = 0\text{ V}$, $I_{SD} = 20\text{ A}$	-	3.6	-	V
t_{rr}	Reverse recovery time	$I_{SD} = 20\text{ A}$, $V_{DD} = 800\text{ V}$, $V_{GS} = -5\text{ to }18\text{ V}$, $R_{G(on)} = 8.2\ \Omega$, $R_{G(off)} = 3.3\ \Omega$	-	22	-	ns
Q_{rr}	Reverse recovery charge		-	131	-	nC
I_{RRM}	Reverse recovery current		-	16	-	A
t_{rr}	Reverse recovery time	$I_{SD} = 20\text{ A}$, $V_{DD} = 800\text{ V}$, $V_{GS} = -5\text{ to }18\text{ V}$, $R_{G(on)} = 8.2\ \Omega$, $R_{G(off)} = 3.3\ \Omega$, $T_J = 175\text{ }^\circ\text{C}$	-	26	-	ns
Q_{rr}	Reverse recovery charge		-	483	-	nC
I_{RRM}	Reverse recovery current		-	28	-	A

2 NTC

Table 4. Absolute maximum ratings for NTC temperature sensor, considered as stand-alone

Symbol	Parameter	Test conditions	Min.	Typ.	Max.	Unit
R ₂₅	Resistance rating	T = 25 °C		10		kΩ
ΔR ₂₅ /R	Resistance tolerance		-2		+2	%
R ₁₀₀	Resistance rating	T = 100 °C		674.8		Ω
ΔR ₁₀₀ /R	Resistance tolerance		-4.75		4.75	%
R _{25/50}	B-value	T = 25 °C to 50 °C		3940		K
R _{25/85}		T = 25 °C to 85 °C		3980		
R _{25/100}		T = 25 °C to 100 °C (±1%)		4000		
T	Operating temperature range		-40		150	°C

3 Electrical topology and pin description

Figure 1. ACEPACK DMT-32 pin layout (bottom view)

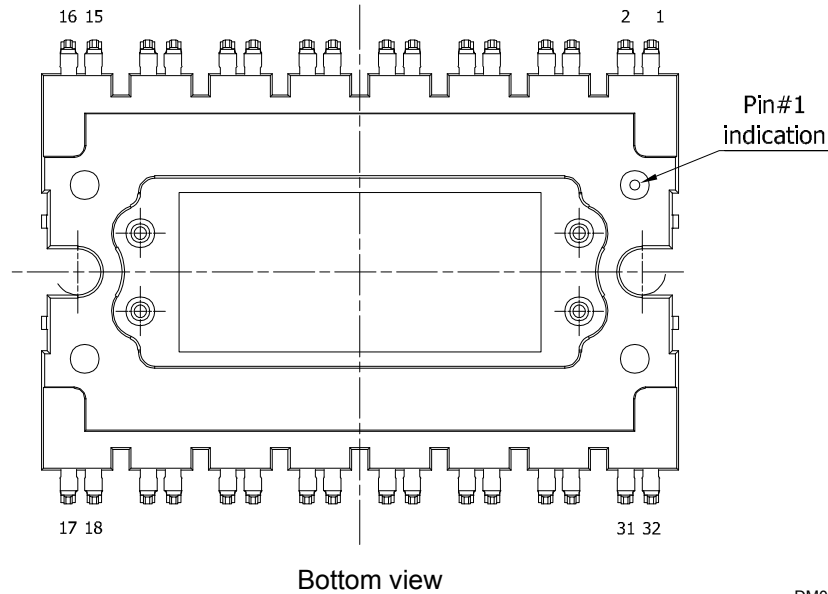

DM00692330_rev_6_pin_layout

Table 5. Pin description

Pin	Description	Pin	Description
1	NC	17	NC
2	NC	18	NC
3	N1	19	P2
4	N1	20	P2
5	S2	21	NC
6	G2	22	G3
7	PH1	23	S3
8	PH1	24	NC
9	NC	25	PH2
10	S1	26	PH2
11	G1	27	G4
12	NC	28	S4
13	P1	29	N2
14	P1	30	N2
15	NC	31	T1 (NTC)
16	NC	32	T2 (NTC)

Figure 2. Electrical topology and pin description

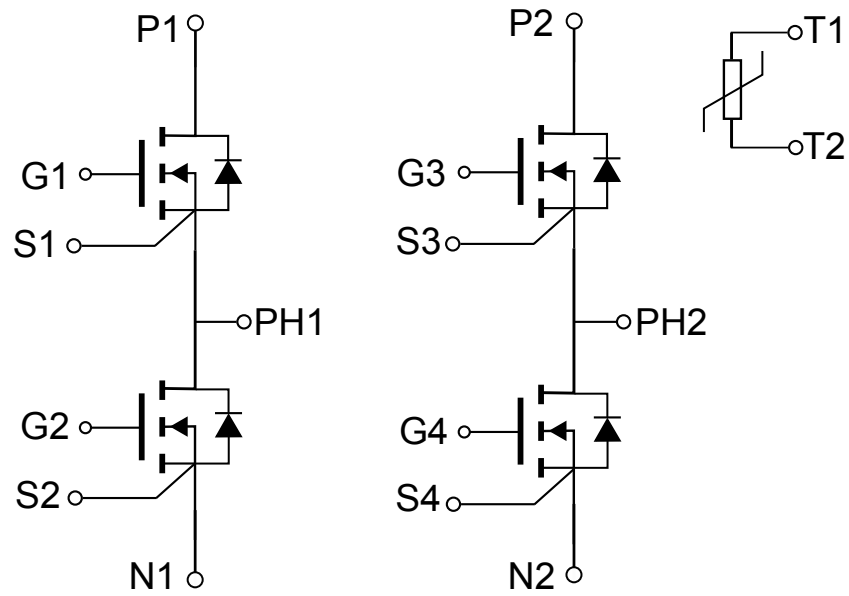

4 Electrical characteristics (curves)

Figure 3. Typical output characteristics ($T_J = -40\text{ }^\circ\text{C}$)

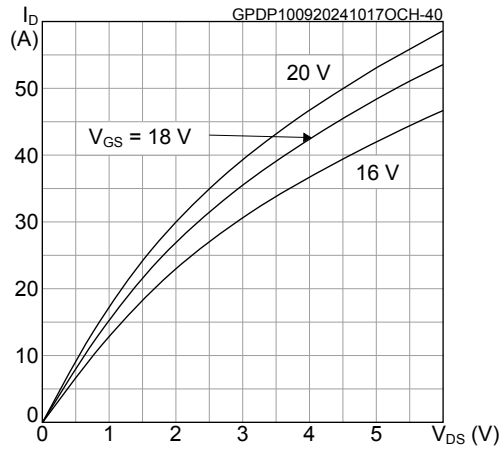

Figure 4. Typical output characteristics ($T_J = 25\text{ }^\circ\text{C}$)

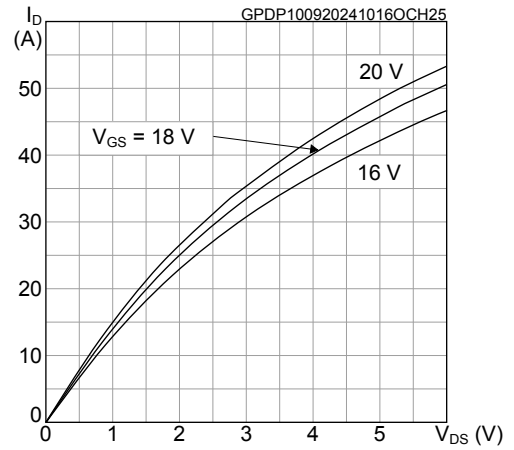

Figure 5. Typical output characteristics ($T_J = 175\text{ }^\circ\text{C}$)

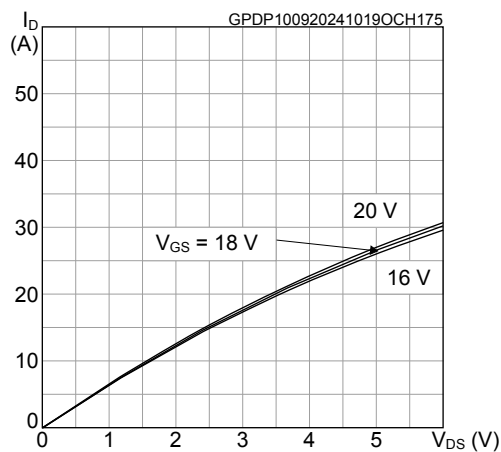

Figure 6. Typical transfer characteristics

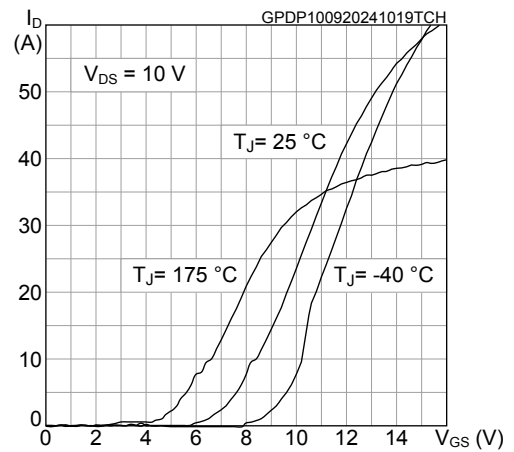

Figure 7. Typical reverse conduction characteristics ($T_J = -40\text{ }^\circ\text{C}$)

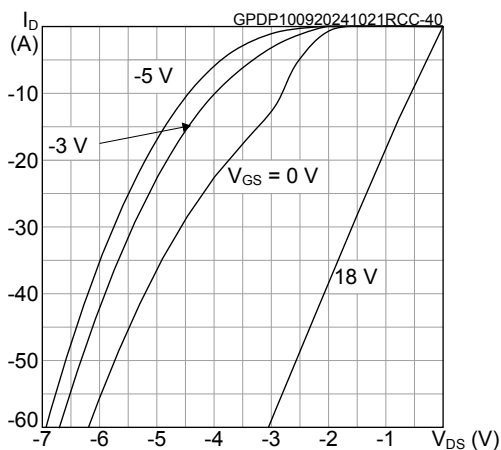

Figure 8. Typical reverse conduction characteristics ($T_J = 25\text{ }^\circ\text{C}$)

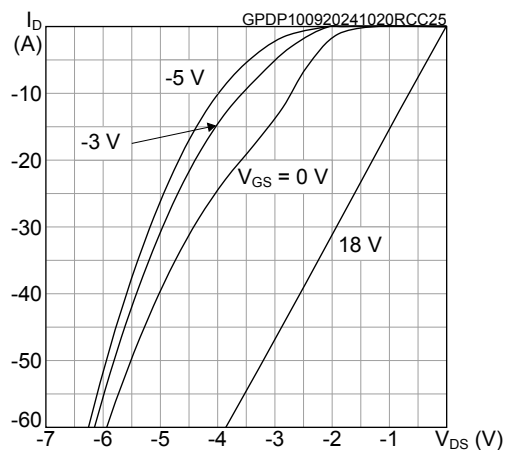

Figure 9. Typical reverse conduction characteristics
($T_J = 175\text{ }^\circ\text{C}$)

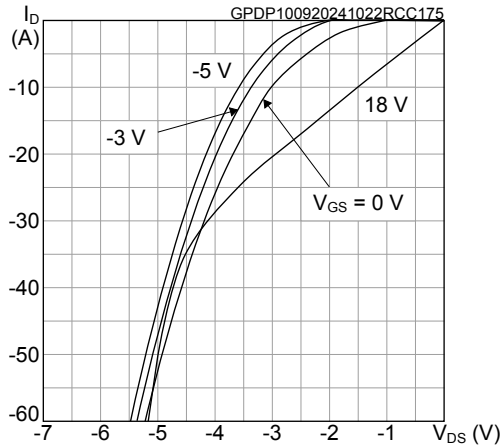

Figure 10. Typical switching energy vs temperature

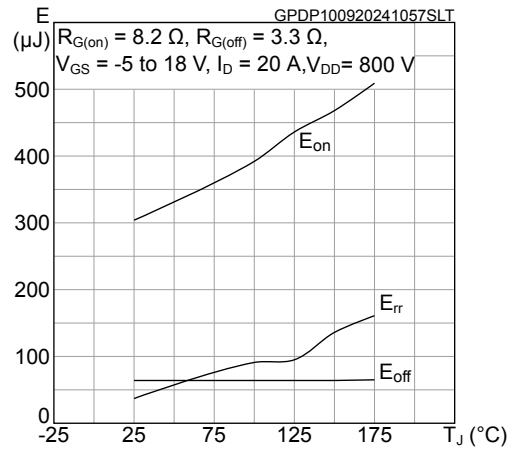

Figure 11. Typical switching energy vs drain current
($T_J = 25\text{ }^\circ\text{C}$)

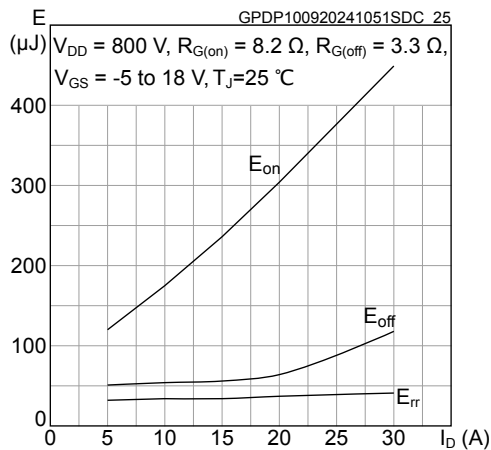

Figure 12. Typical switching energy vs drain current
($T_J = 175\text{ }^\circ\text{C}$)

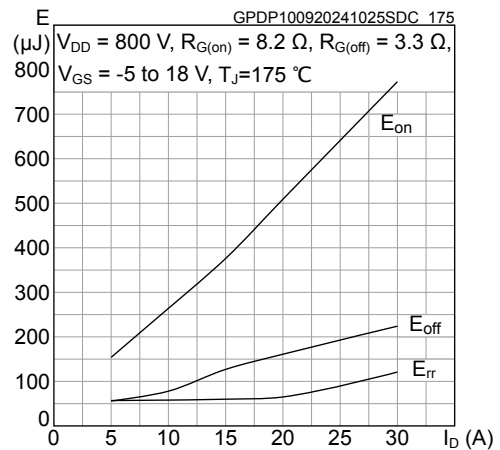

Figure 13. Typical switching energy vs gate resistance
($T_J = 25\text{ }^\circ\text{C}$)

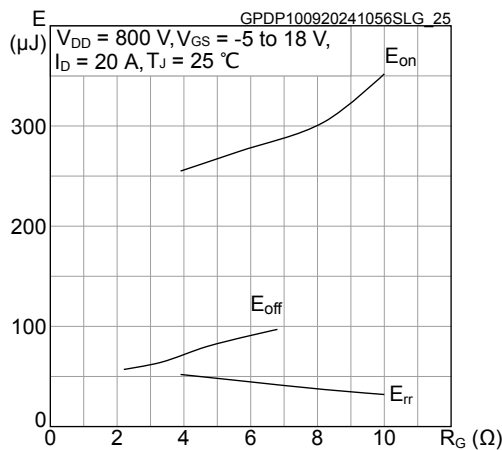

Figure 14. Typical switching energy vs gate resistance
($T_J = 175\text{ }^\circ\text{C}$)

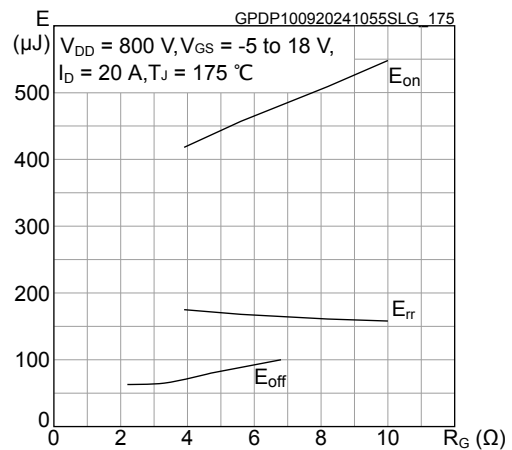

Figure 15. Typical switching energy vs bus voltage
($T_J = 25\text{ }^\circ\text{C}$)

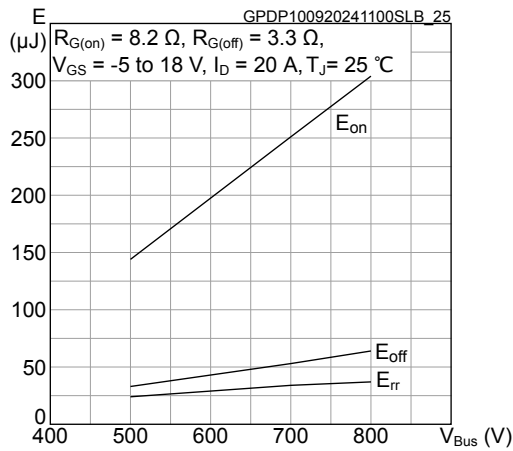

Figure 16. Typical switching energy vs bus voltage
($T_J = 175\text{ }^\circ\text{C}$)

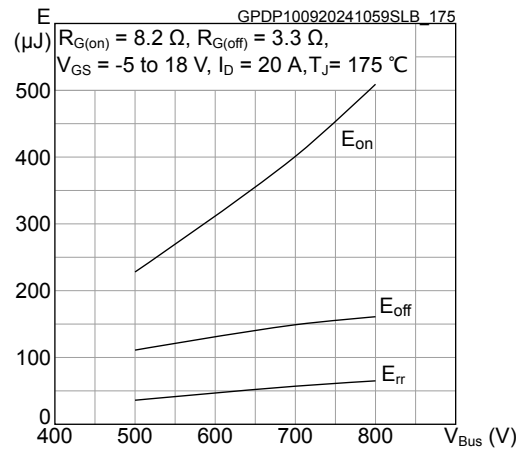
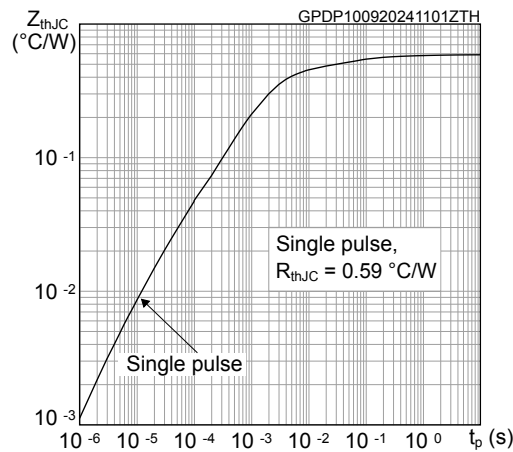

Figure 17. Typical transient thermal impedance



5 Package information

To meet environmental requirements, ST offers these devices in different grades of **ECOPACK** packages, depending on their level of environmental compliance. ECOPACK specifications, grade definitions, and product status are available at: www.st.com. ECOPACK is an ST trademark.

5.1 ACEPACK DMT-32 package information

Figure 18. ACEPACK DMT-32 package outline

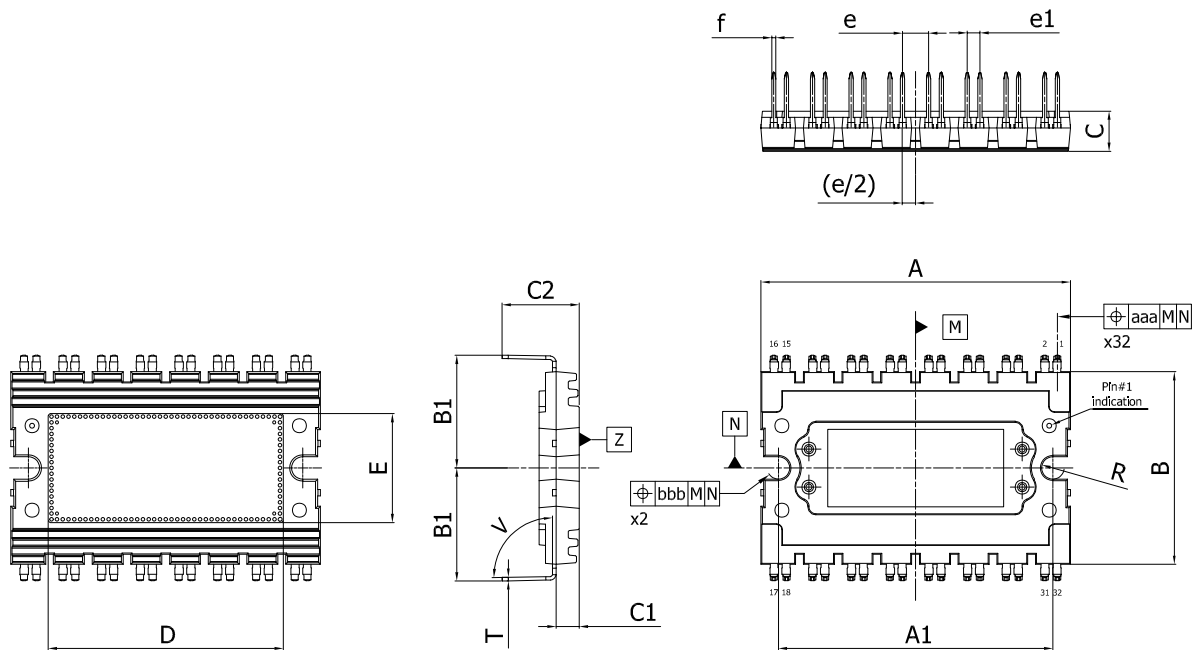

DM00692330_6

Table 6. ACEPACK DMT-32 package mechanical data

Dim.	mm		
	Min.	Typ.	Max.
A	43.50	44.00	44.50
A1	38.80	39.00	39.20
B	26.90	27.40	27.90
B1	15.90	16.05	16.20
C	5.50	5.70	5.90
C1	3.15	3.30	3.45
C2	10.85	11.00	11.15
e	3.50	3.70	3.90
e1	1.60	1.80	2.00
D	33.00	33.40	33.80
E	15.10	15.50	15.90
f	0.60	0.65	0.70
R	1.60		1.70
T	0.48	0.53	0.58
V	90°		93°
aaa		0.30	
bbb		0.15	

Table 7. Ratings for module

Symbol	Parameter	Value	Unit
V _{ISO}	Isolation voltage (f = 50 Hz, t = 60 s)	3	kV
CTI	Comparative tracking index	600	V
T _{stg}	Storage temperature range	-40 to 150	°C

Revision history

Table 8. Document revision history

Date	Revision	Changes
23-May-2022	1	First release.
24-Aug-2022	2	Updated <i>Table 2. Electrical characteristics - SiC MOSFET.</i>
16-Sep-2024	3	Modified Features, Applications and Description . Modified Section 1: Inverter switch, Figure 1. ACEPACK DMT-32 pin layout (bottom view) and Figure 2. Electrical topology and pin description . Added Section 4: Electrical characteristics (curves) . Updated Section 5.1: ACEPACK DMT-32 package information .

Contents

1	Inverter switch	2
2	NTC	4
3	Electrical topology and pin description	5
4	Electrical characteristics (curves)	7
5	Package information	10
	5.1 ACEPACK DMT-32 package information	10
	Revision history	12

IMPORTANT NOTICE – READ CAREFULLY

STMicroelectronics NV and its subsidiaries (“ST”) reserve the right to make changes, corrections, enhancements, modifications, and improvements to ST products and/or to this document at any time without notice. Purchasers should obtain the latest relevant information on ST products before placing orders. ST products are sold pursuant to ST’s terms and conditions of sale in place at the time of order acknowledgment.

Purchasers are solely responsible for the choice, selection, and use of ST products and ST assumes no liability for application assistance or the design of purchasers’ products.

No license, express or implied, to any intellectual property right is granted by ST herein.

Resale of ST products with provisions different from the information set forth herein shall void any warranty granted by ST for such product.

ST and the ST logo are trademarks of ST. For additional information about ST trademarks, refer to www.st.com/trademarks. All other product or service names are the property of their respective owners.

Information in this document supersedes and replaces information previously supplied in any prior versions of this document.

© 2024 STMicroelectronics – All rights reserved