

Low voltage NPN power transistor

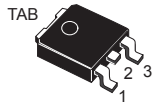

DPAK

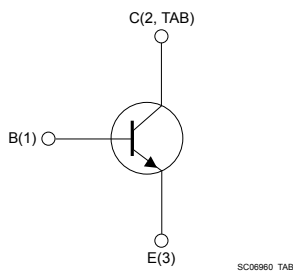

Features

- Surface-mounting TO-252 power package in tape and reel
- Complementary to the PNP type [MJD32CT4](#)

Application

- General purpose linear and switching equipment

Description

The device is manufactured in planar technology with a “base island” layout. The resulting transistor shows exceptional high gain performance coupled with very low saturation voltage.

Product status link

[MJD31CT4](#)

Product summary

Order code	MJD31CT4
Marking	MJD31C
Package	DPAK
Packing	Tape and reel

1 Electrical ratings

Table 1. Absolute maximum ratings

Symbol	Parameter	Value	Unit
V_{CBO}	Collector-base voltage ($I_E = 0$ A)	100	V
V_{CEO}	Collector-emitter voltage ($I_B = 0$ A)	100	V
V_{EBO}	Collector-base voltage ($I_C = 0$ A)	5	V
I_C	Collector current	3	A
I_{CM}	Collector peak current	5	A
I_B	Base current	1	A
P_{TOT}	Total power dissipation at $T_C = 25$ °C	15	W
T_{stg}	Storage temperature range	-65 to 150	°C
T_J	Operating junction temperature range		°C

Table 2. Thermal data

Symbol	Parameter	Value	Unit
R_{thJC}	Thermal resistance, junction-to-case	8.3	°C/W
$R_{thJA}^{(1)}$	Thermal resistance, junction-to-ambient	50	°C/W

1. When mounted on a standard 1 inch² area of FR-4 PCB with 2-oz copper.

2 Electrical characteristics

$T_J = 25^\circ\text{C}$ unless otherwise specified.

Table 3. Electrical characteristics

Symbol	Parameter	Test conditions	Min.	Typ.	Max.	Unit
I_{CES}	Collector cut-off current	$V_{CE} = 100\text{ V}, V_{BE} = 0\text{ V}$		-	20	μA
I_{CEO}	Collector cut-off current	$V_{CB} = 60\text{ V}, I_B = 0\text{ V}$		-	50	μA
I_{EBO}	Emitter cut-off current	$V_{EB} = 5\text{ V}, I_C = 0\text{ A}$		-	0.1	mA
$V_{CEO(sus)}^{(1)}$	Collector-emitter sustaining voltage	$I_C = 30\text{ V}, I_B = 0\text{ A}$	100	-		V
$V_{CE(sat)}^{(1)}$	Collector-emitter saturation voltage	$I_C = 3\text{ A}, I_B = 375\text{ mA}$		-	1.2	V
$V_{BE(on)}^{(1)}$	Base-emitter on voltage	$I_C = 3\text{ A}, V_{CE} = 4\text{ V}$		-	1.8	V
h_{FE}	DC current gain	$I_C = 1\text{ A}, V_{CE} = 4\text{ V}$	25	-		
		$I_C = 3\text{ A}, V_{CE} = 4\text{ V}$	10	-	50	

1. Pulse test: pulse duration $\leq 300\ \mu\text{s}$, duty cycle $\leq 2\%$.

2.1 Electrical characteristics (curves)

Figure 1. Safe operating area

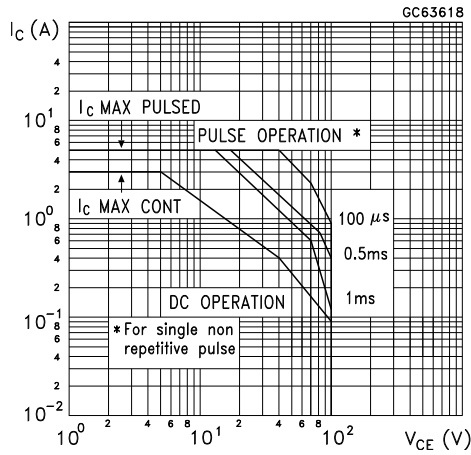

Figure 2. Derating curves

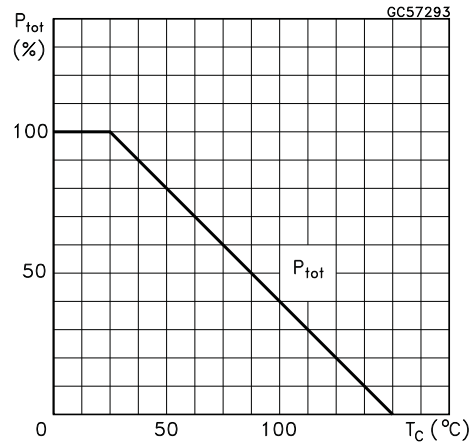

Figure 3. DC current gain ($V_{CE} = 2\text{ V}$)

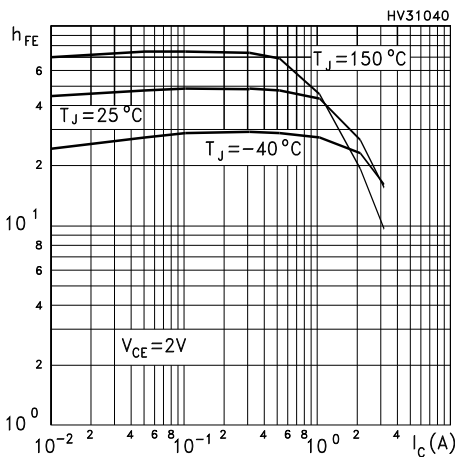

Figure 4. DC current gain ($V_{CE} = 4\text{ V}$)

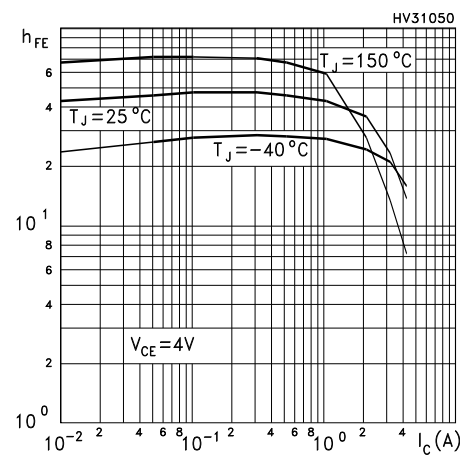

Figure 5. Collector-emitter saturation voltage

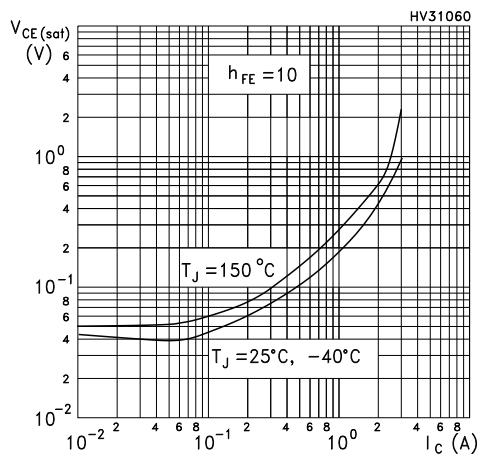

Figure 6. Base-emitter saturation voltage

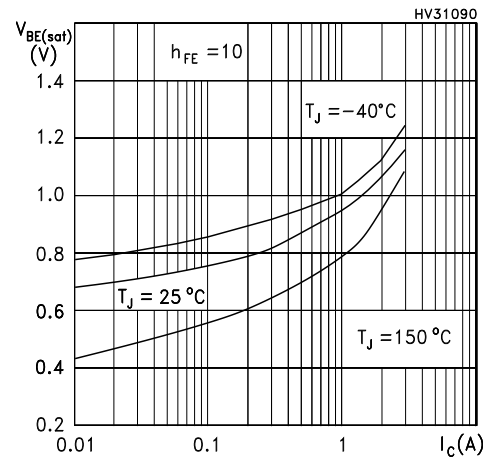

Figure 7. Base-emitter on voltage

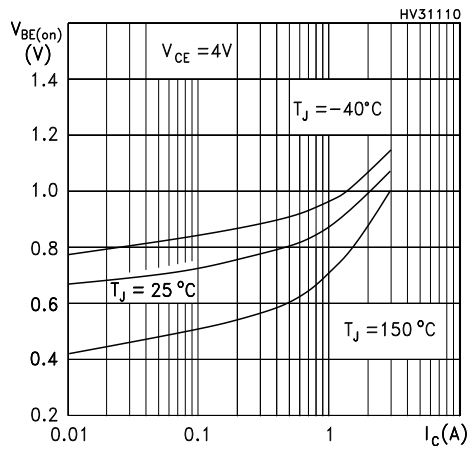

Figure 8. Resistive load switching time (on)

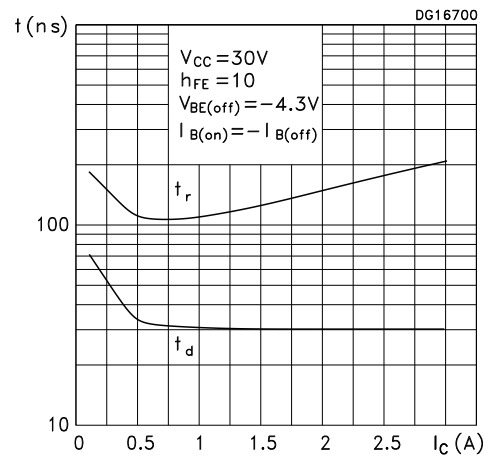
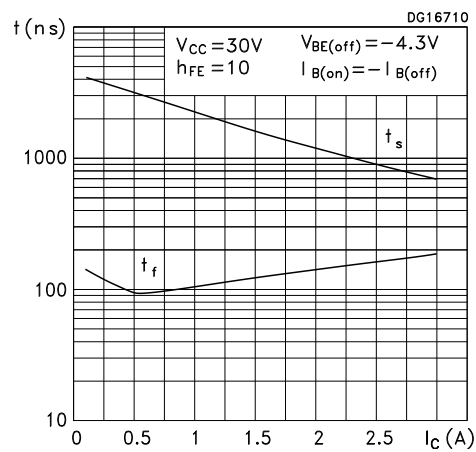

Figure 9. Resistive load switching time (off)



3 Package information

In order to meet environmental requirements, ST offers these devices in different grades of **ECOPACK** packages, depending on their level of environmental compliance. ECOPACK specifications, grade definitions and product status are available at: www.st.com. ECOPACK is an ST trademark.

3.1 DPAK (TO-252) type C package information

Figure 10. DPAK (TO-252) type C package outline

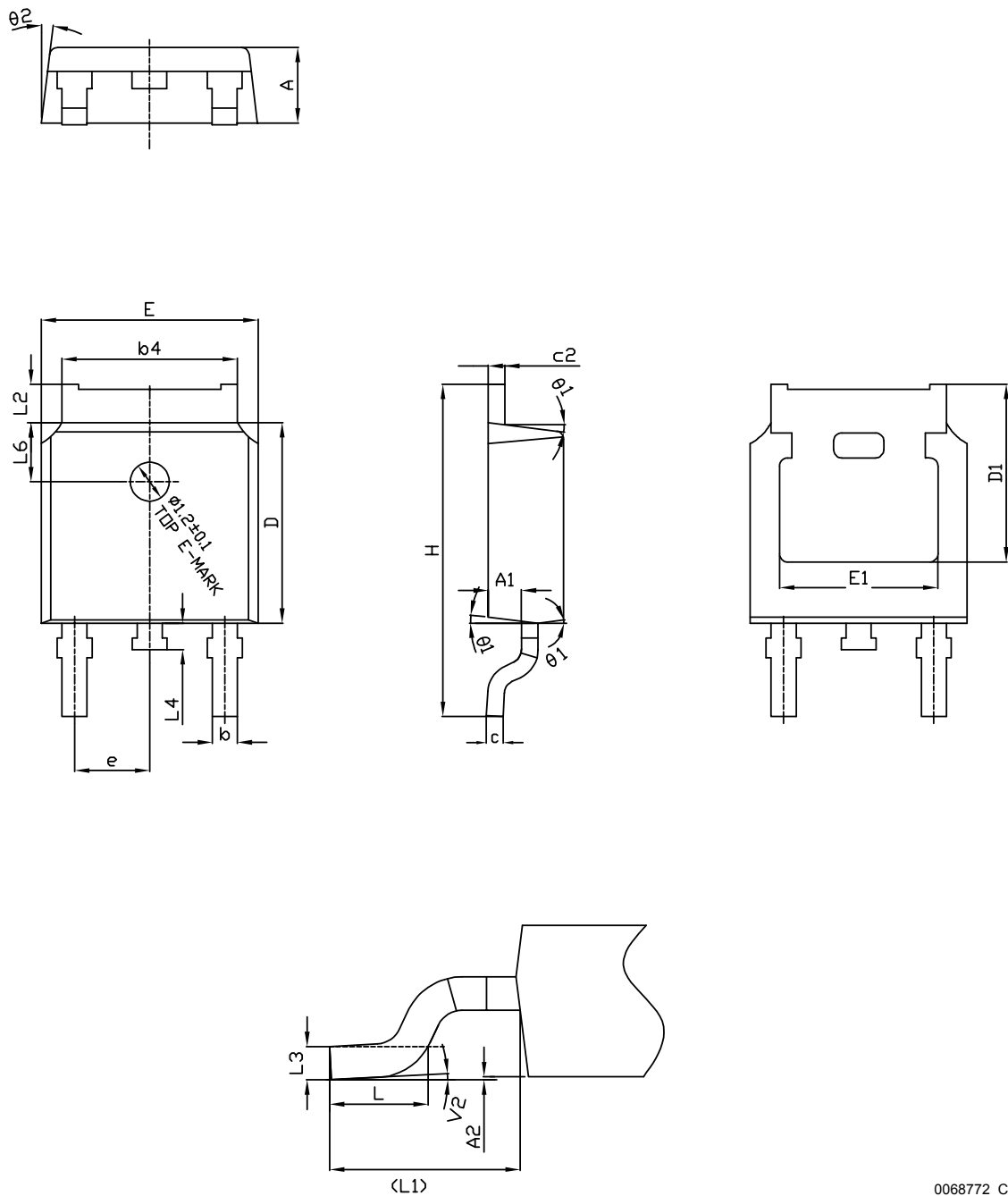

0068772_C_34

Table 4. DPAK (TO-252) type C mechanical data

Dim.	mm		
	Min.	Typ.	Max.
A	2.20	2.30	2.38
A1	0.90	1.01	1.10
A2	0.00		0.10
b	0.72		0.85
b4	5.13	5.33	5.46
c	0.47		0.60
c2	0.47		0.60
D	6.00	6.10	6.20
D1	5.15	5.40	5.65
E	6.50	6.60	6.70
E1	4.70	4.85	5.00
e	2.186	2.286	2.386
H	9.80	10.10	10.40
L	1.40	1.50	1.70
L1	2.90 REF		
L2	0.90		1.25
L3	0.51 BSC		
L4	0.60	0.80	1.00
L6	1.80 BSC		
θ1	5°	7°	9°
θ2	5°	7°	9°
V2	0°		8°

Figure 11. DPAK (TO-252) recommended footprint (dimensions are in mm)

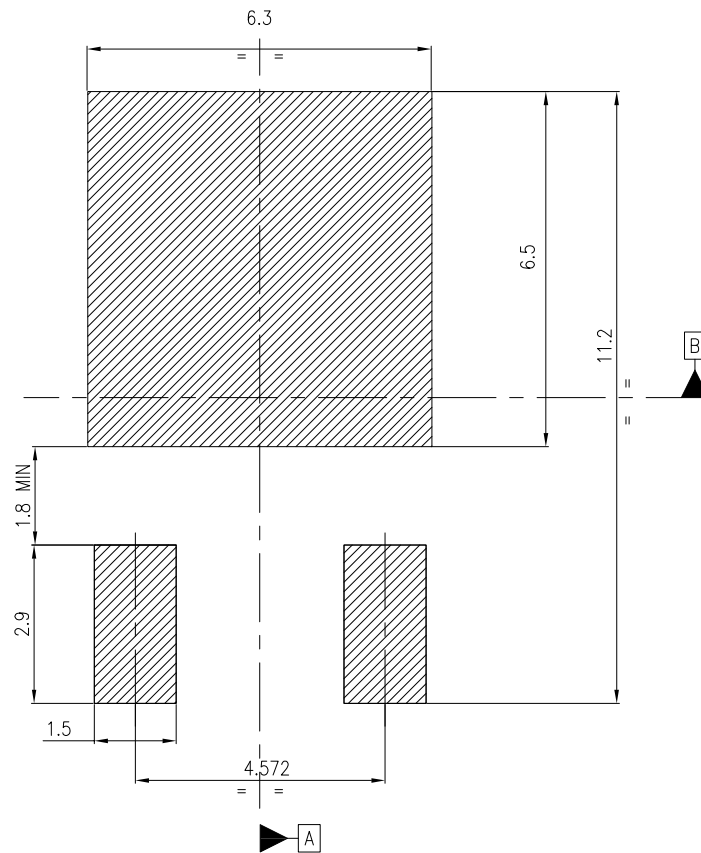

Notes:

- 1) This footprint is able to ensure insulation up to 630 Vrms (according to CEI IEC 664-1)
- 2) The device must be positioned within $\boxed{\oplus 0.05 \text{ A B}}$

FP_0068772_34

3.2 DPAK (TO-252) packing information

Figure 12. DPAK (TO-252) tape outline

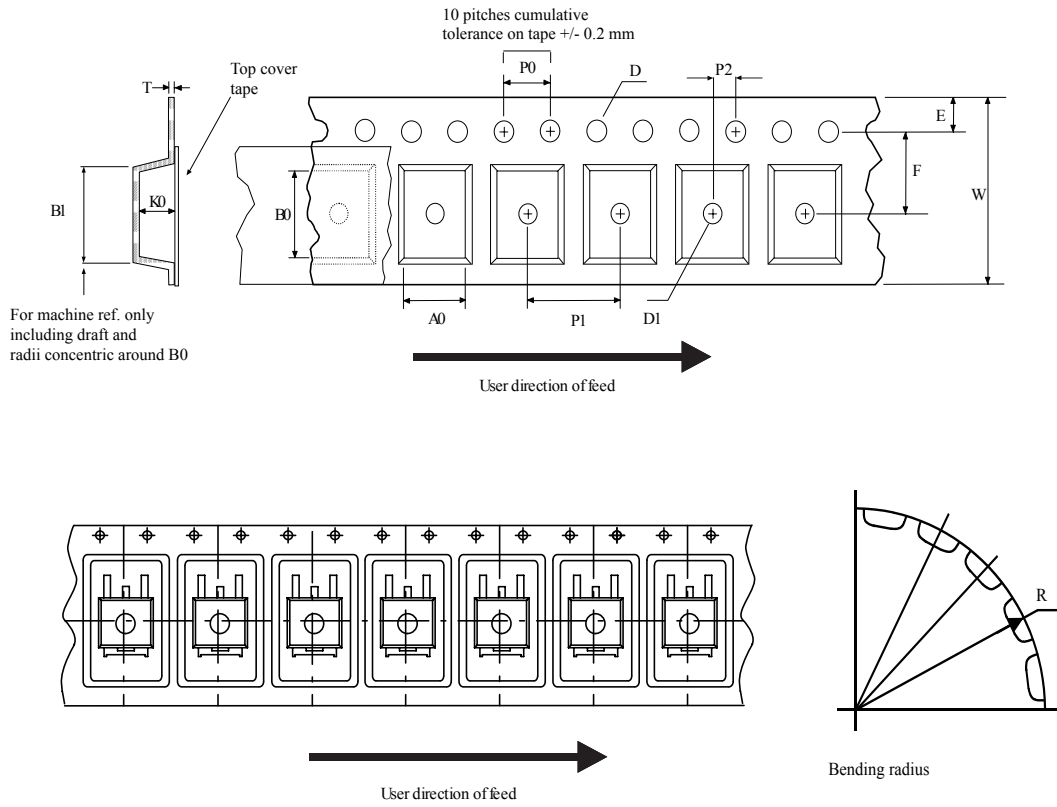

AM08852v1

Figure 13. DPAK (TO-252) reel outline

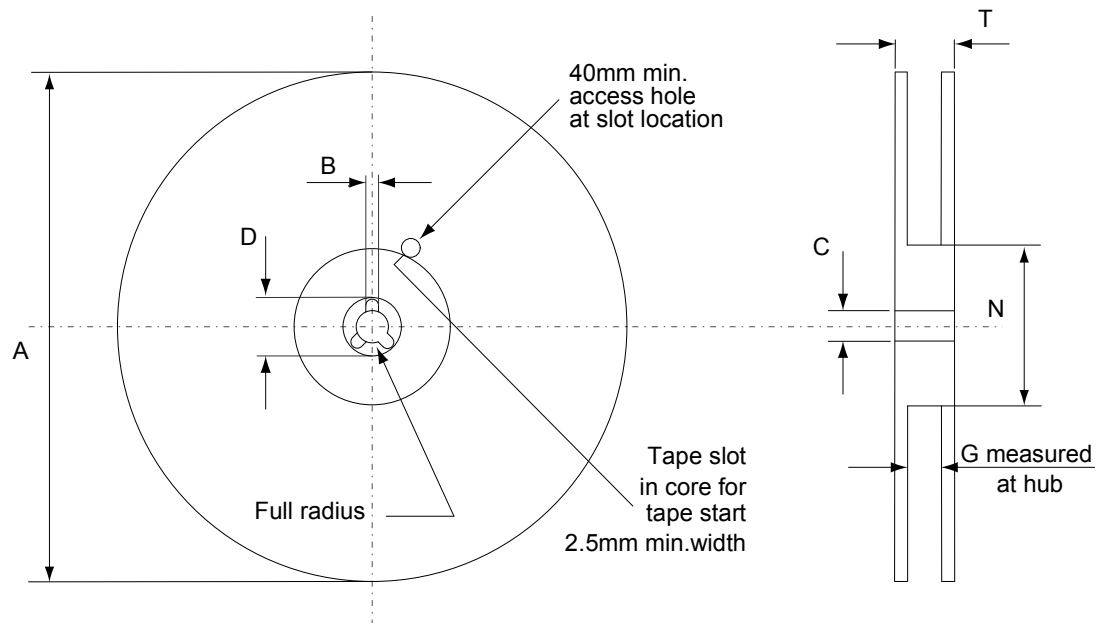

AM06038v1

Table 5. DPAK (TO-252) tape and reel mechanical data

Dim.	Tape		Dim.	Reel	
	mm			mm	
	Min.	Max.		Min.	Max.
A0	6.8	7	A		330
B0	10.4	10.6	B	1.5	
B1		12.1	C	12.8	13.2
D	1.5	1.6	D	20.2	
D1	1.5		G	16.4	18.4
E	1.65	1.85	N	50	
F	7.4	7.6	T		22.4
K0	2.55	2.75			
P0	3.9	4.1	Base qty.		2500
P1	7.9	8.1	Bulk qty.		2500
P2	1.9	2.1			
R	40				
T	0.25	0.35			
W	15.7	16.3			

Revision history

Table 6. Document revision history

Date	Revision	Changes
04-Jul-2024	1	First release.

Contents

1	Electrical ratings	2
2	Electrical characteristics	3
2.1	Electrical characteristics (curves)	4
3	Package information	6
3.1	DPAK (TO-252) type C package information	6
3.2	DPAK (TO-252) packing information	9
	Revision history	11

IMPORTANT NOTICE – READ CAREFULLY

STMicroelectronics NV and its subsidiaries (“ST”) reserve the right to make changes, corrections, enhancements, modifications, and improvements to ST products and/or to this document at any time without notice. Purchasers should obtain the latest relevant information on ST products before placing orders. ST products are sold pursuant to ST’s terms and conditions of sale in place at the time of order acknowledgment.

Purchasers are solely responsible for the choice, selection, and use of ST products and ST assumes no liability for application assistance or the design of purchasers’ products.

No license, express or implied, to any intellectual property right is granted by ST herein.

Resale of ST products with provisions different from the information set forth herein shall void any warranty granted by ST for such product.

ST and the ST logo are trademarks of ST. For additional information about ST trademarks, refer to www.st.com/trademarks. All other product or service names are the property of their respective owners.

Information in this document supersedes and replaces information previously supplied in any prior versions of this document.

© 2024 STMicroelectronics – All rights reserved