

Automotive-grade silicon carbide Power MOSFET 750 V, 60 mΩ typ., 30 A in an HiP247-4 package

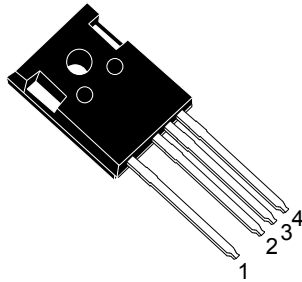

HiP247-4

ND1TPS2DS3G4

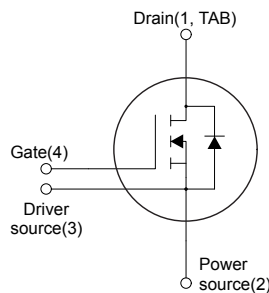

Features

Order code	V_{DS}	$R_{DS(on)}$ typ.	I_D
SCT060W75G3-4AG	750 V	60 mΩ	30 A

- AEC-Q101 qualified 
- Very low $R_{DS(on)}$ over the entire temperature range
- High speed switching performances
- Very fast and robust intrinsic body diode
- Very high operating junction temperature capability ($T_J = 200\text{ °C}$)
- Source sensing pin for increased efficiency

Applications

- DC/DC converter for EV/HEV
- Main inverter (electric traction)
- On board charger (OBC)

Description

This silicon carbide Power MOSFET device has been developed using ST's advanced and innovative 3rd generation SiC MOSFET technology. The device features a very low $R_{DS(on)}$ over the entire temperature range combined with low capacitances and very high switching operations, which improve application performance in frequency, energy efficiency, system size and weight reduction.

Product status link

[SCT060W75G3-4AG](#)

Product summary

Order code	SCT060W75G3-4AG
Marking	60W75G34AG
Package	HiP247-4
Packing	Tube

1 Electrical ratings

Table 1. Absolute maximum ratings

Symbol	Parameter	Value	Unit
V_{DS}	Drain-source voltage	750	V
V_{GS}	Gate-source voltage	-10 to 22	V
	Gate-source voltage (recommended operating values)	-5 to 18	
	Gate-source transient voltage, $t_p < 1 \mu s$, $t \leq 10$ hours over lifetime	-11 to 25	
$I_D^{(1)}$	Drain current (continuous) at $T_C = 25 \text{ }^\circ\text{C}$	30	A
	Drain current (continuous) at $T_C = 100 \text{ }^\circ\text{C}$	30	
$I_{DM}^{(2)}$	Drain current (pulsed)	128	A
P_{TOT}	Total power dissipation at $T_C = 25 \text{ }^\circ\text{C}$	201	W
T_{stg}	Storage temperature range	-55 to 200	$^\circ\text{C}$
T_J	Operating junction temperature range		$^\circ\text{C}$

- I_D is limited by package.
- Pulse width is limited by safe operating area.

Table 2. Thermal data

Symbol	Parameter	Value	Unit
R_{thJC}	Thermal resistance, junction-to-case	0.87	$^\circ\text{C}/\text{W}$
R_{thJA}	Thermal resistance, junction-to-ambient	40	$^\circ\text{C}/\text{W}$

2 Electrical characteristics

$T_C = 25\text{ °C}$ unless otherwise specified.

Table 3. On/off states

Symbol	Parameter	Test conditions	Min.	Typ.	Max.	Unit
$V_{(BR)DSS}$	Drain-source breakdown voltage	$V_{GS} = 0\text{ V}, I_D = 1\text{ mA}$	750			V
I_{DSS}	Zero gate voltage drain current	$V_{GS} = 0\text{ V}, V_{DS} = 750\text{ V}$			10	μA
I_{GSS}	Gate-body leakage current	$V_{DS} = 0\text{ V}, V_{GS} = -10\text{ to }22\text{ V}$			± 100	nA
$V_{GS(th)}$	Gate threshold voltage	$V_{DS} = V_{GS}, I_D = 1\text{ mA}$	1.8	3.0	4.2	V
$R_{DS(on)}$	Static drain-source on-resistance	$V_{GS} = 15\text{ V}, I_D = 15\text{ A}$		76		m Ω
		$V_{GS} = 18\text{ V}, I_D = 15\text{ A}$		60	81	
		$V_{GS} = 18\text{ V}, I_D = 15\text{ A}, T_J = 200\text{ °C}$		95		

Table 4. Dynamic

Symbol	Parameter	Test conditions	Min.	Typ.	Max.	Unit
C_{iss}	Input capacitance	$V_{DS} = 400\text{ V}, f = 1\text{ MHz}, V_{GS} = 0\text{ V}$	-	670	-	pF
C_{oss}	Output capacitance		-	59	-	pF
C_{rss}	Reverse transfer capacitance		-	9	-	pF
Q_g	Total gate charge	$V_{DD} = 400\text{ V}, V_{GS} = -5\text{ to }18\text{ V}, I_D = 15\text{ A}$	-	29	-	nC
Q_{gs}	Gate-source charge		-	9	-	nC
Q_{gd}	Gate-drain charge		-	8.6	-	nC
R_g	Gate input resistance	$f = 1\text{ MHz}, I_D = 0\text{ A}$	-	1.4	-	Ω

Table 5. Switching energy (inductive load)

Symbol	Parameter	Test conditions	Min.	Typ.	Max.	Unit
E_{on}	Turn-on switching energy	$V_{DD} = 400\text{ V}, I_D = 15\text{ A},$	-	75	-	μJ
E_{off}	Turn-off switching energy	$R_G = 15\text{ }\Omega, V_{GS} = -5\text{ V to }18\text{ V}$	-	31	-	μJ

Table 6. Switching times

Symbol	Parameter	Test conditions	Min.	Typ.	Max.	Unit
$t_{d(on)}$	Turn-on delay time	$V_{DD} = 400\text{ V}, I_D = 15\text{ A},$ $R_G = 15\text{ }\Omega, V_{GS} = -5\text{ to }18\text{ V}$	-	11	-	ns
t_r	Rise time		-	5	-	ns
$t_{d(off)}$	Turn-off delay time		-	23	-	ns
t_f	Fall time		-	14	-	ns

Table 7. Reverse SiC diode characteristics

Symbol	Parameter	Test conditions	Min.	Typ.	Max.	Unit
$I_{SD}^{(1)}$	Continuous diode forward current	$T_C = 25\text{ }^\circ\text{C}$	-		30	A
		$T_C = 100\text{ }^\circ\text{C}$	-		30	
V_{SD}	Diode forward voltage	$I_{SD} = 15\text{ A}$, $V_{GS} = 0\text{ V}$	-	1		V
t_{rr}	Reverse recovery time	$I_{SD} = 15\text{ A}$, $di/dt = 1000\text{ A}/\mu\text{s}$, $V_{DD} = 400\text{ V}$	-	14		ns
Q_{rr}	Reverse recovery charge		-	57		nC
I_{RRM}	Reverse recovery current		-	7		A

1. I_{SD} is limited by package.

2.1 Electrical characteristics (curves)

Figure 1. Safe operating area

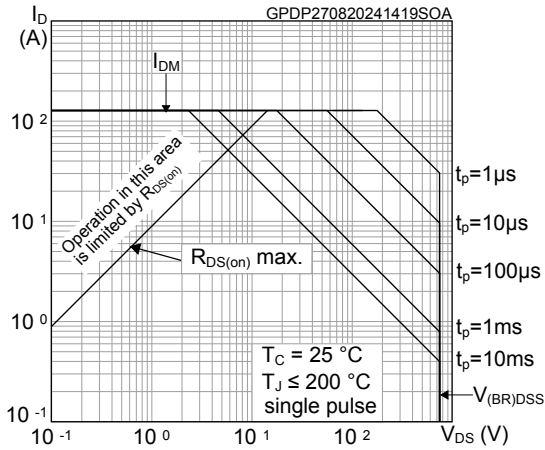

Figure 2. Maximum transient thermal impedance

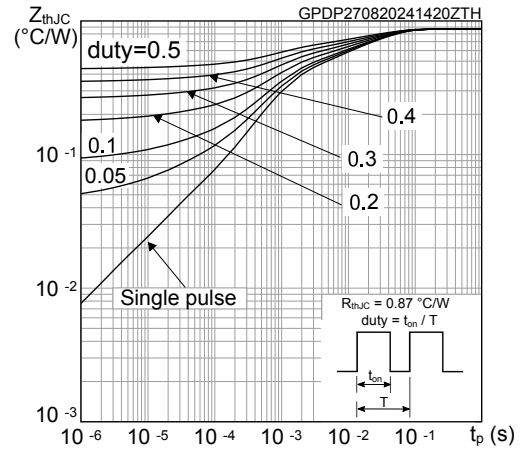

Figure 3. Typical output characteristics ($T_J = 25\text{ °C}$)

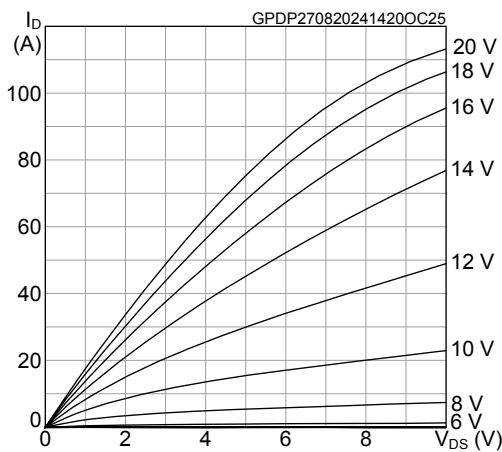

Figure 4. Typical output characteristics ($T_J = 200\text{ °C}$)

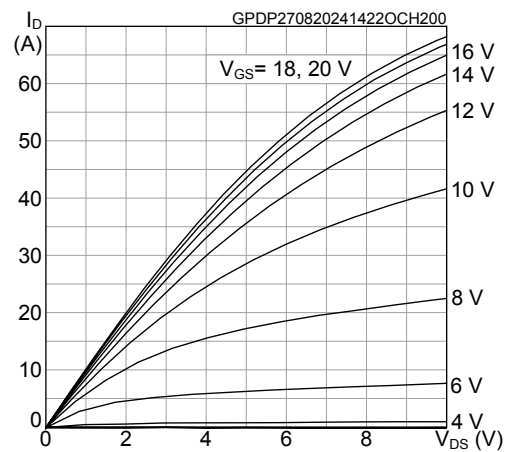

Figure 5. Typical transfer characteristics

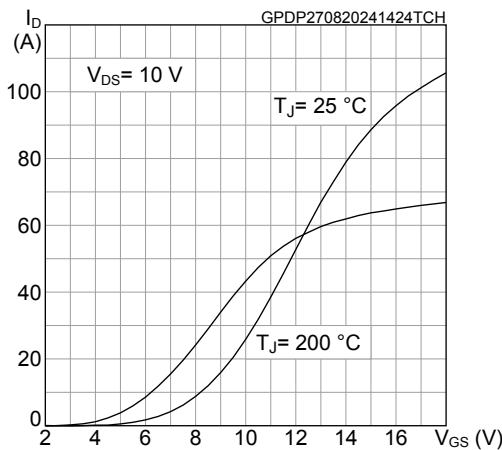

Figure 6. Total power dissipation

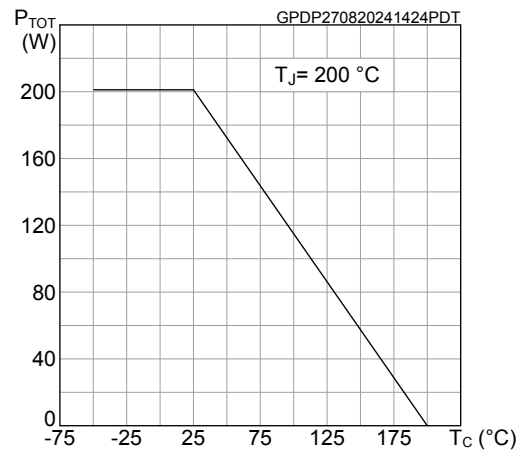

Figure 7. Typical gate charge characteristics

Figure 8. Typical capacitance characteristics

Figure 9. Typical switching energy vs supply voltage

Figure 10. Typical switching energy vs drain current

Figure 11. Typical switching energy vs gate resistance

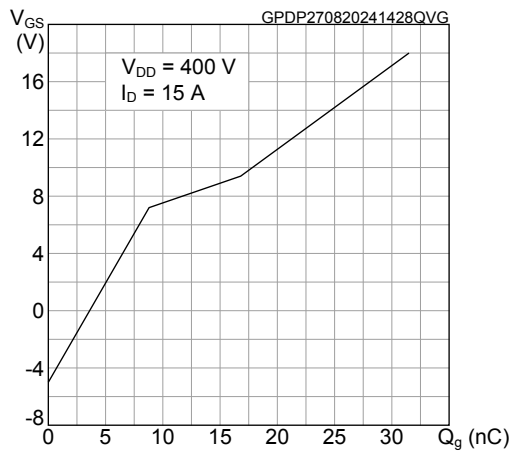
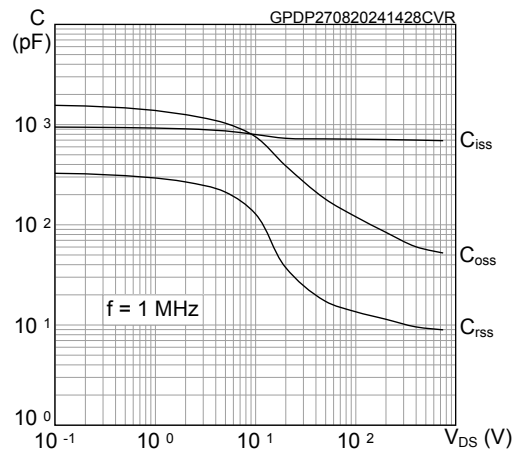
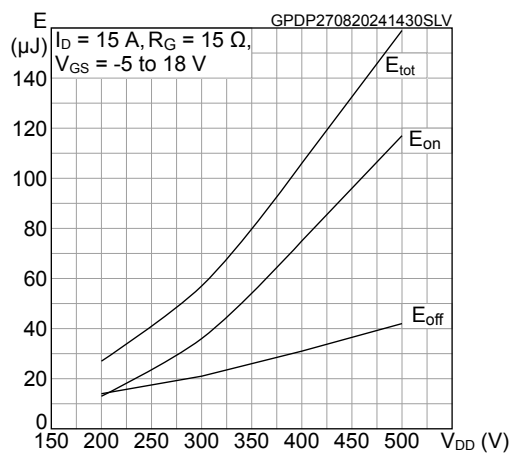
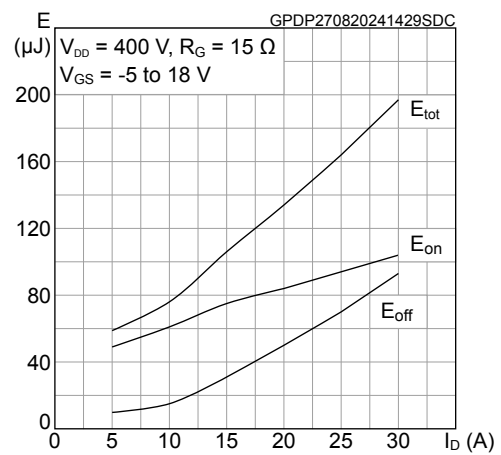
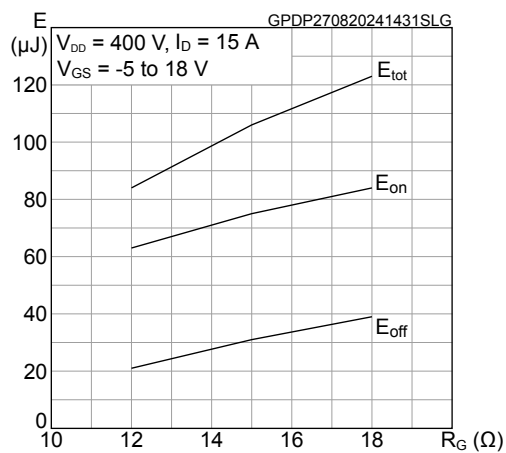
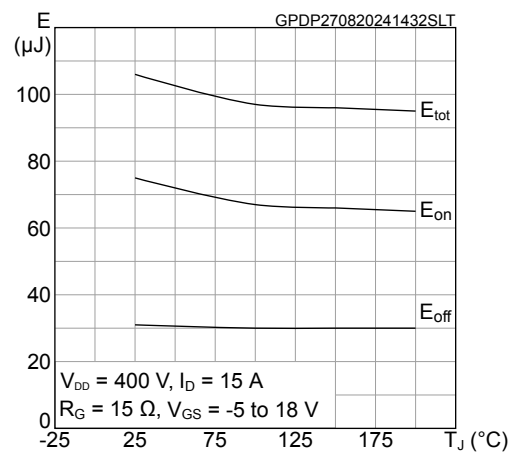
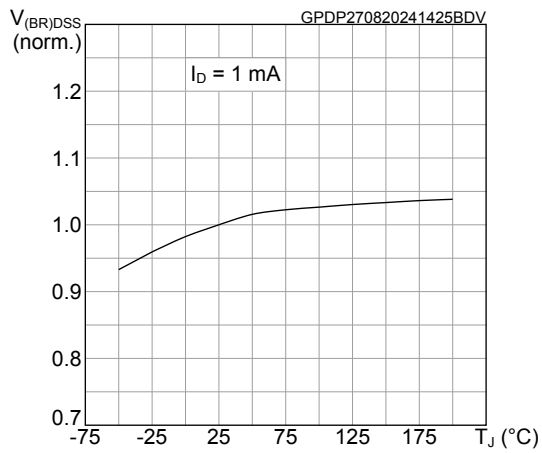
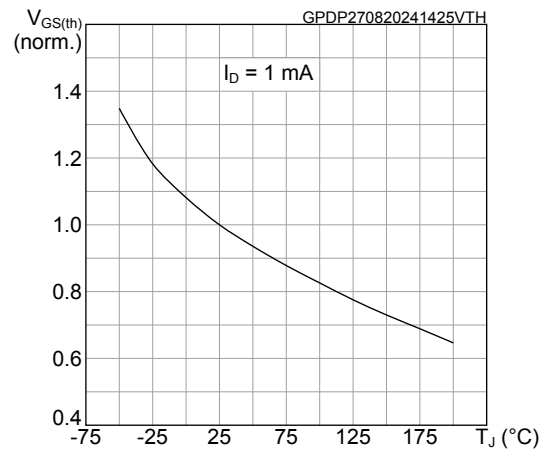
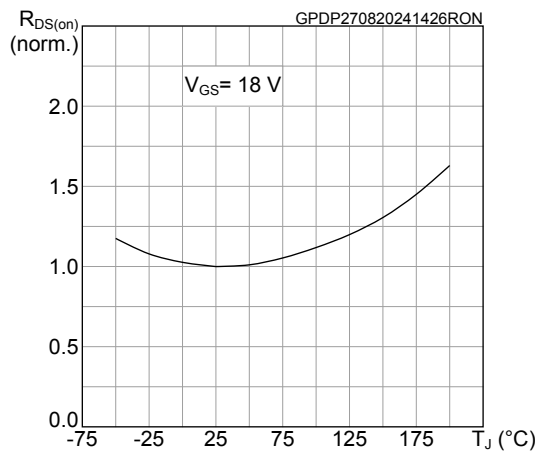
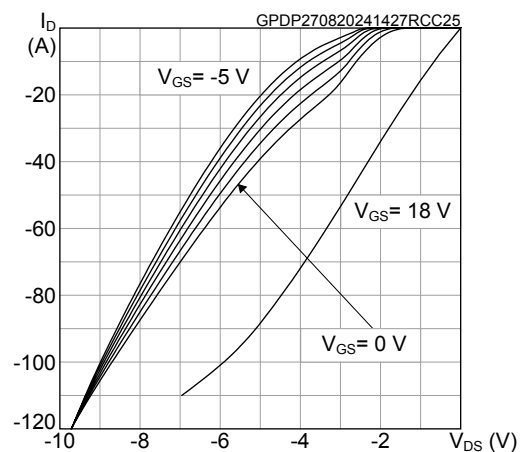
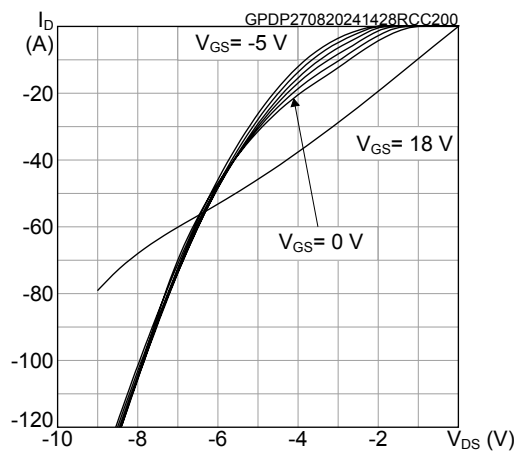
Figure 12. Typical switching energy vs temperature

Figure 13. Normalized breakdown voltage vs temperature

Figure 14. Normalized gate threshold vs temperature

Figure 15. Normalized on-resistance vs temperature

Figure 16. Typical reverse conduction characteristics ($T_J = 25^\circ\text{C}$)

Figure 17. Typical reverse conduction characteristics ($T_J = 200^\circ\text{C}$)

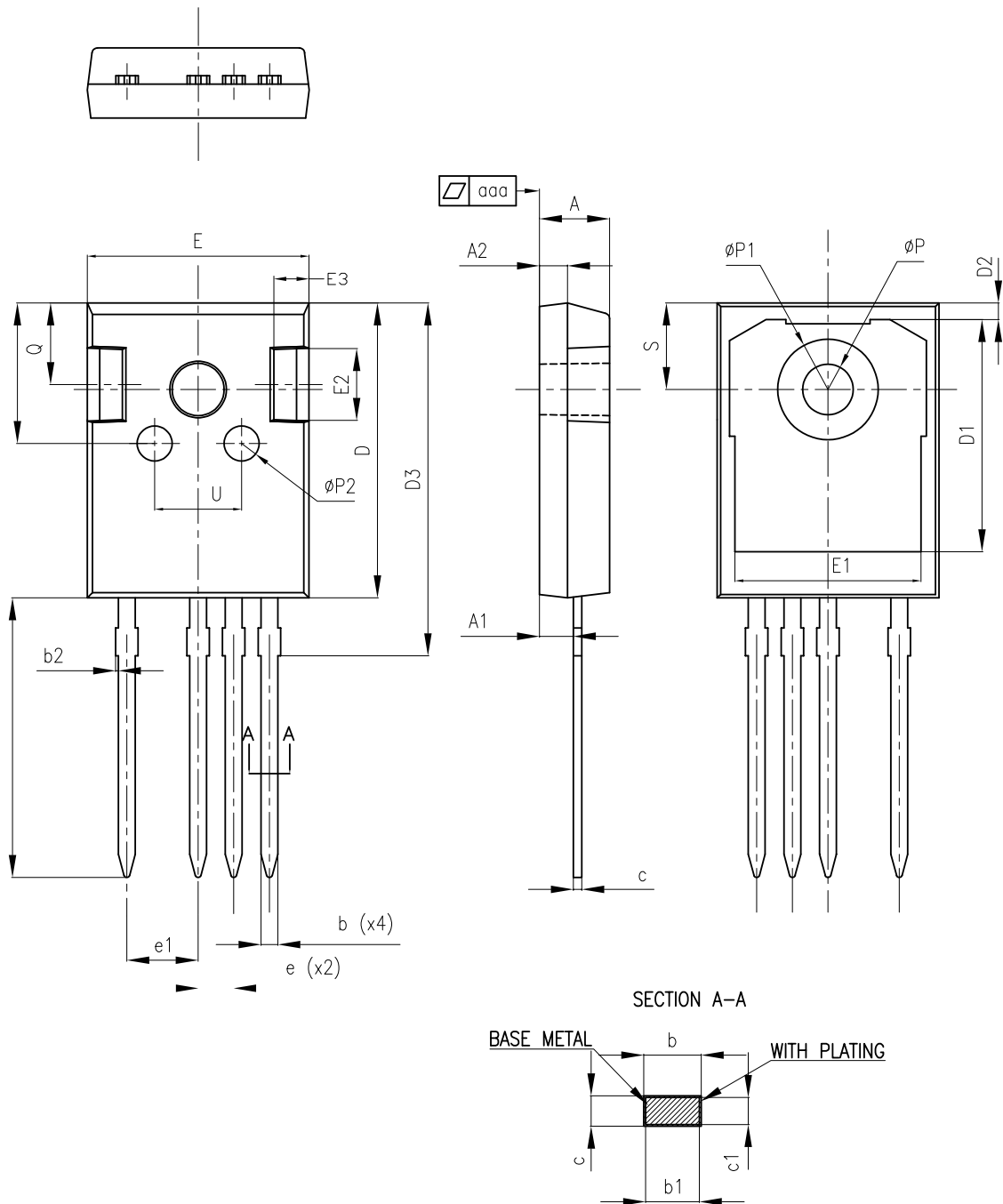
3 Package information

To meet environmental requirements, ST offers these devices in different grades of **ECOPACK** packages, depending on their level of environmental compliance. ECOPACK specifications, grade definitions, and product status are available at: www.st.com. ECOPACK is an ST trademark.

3.1 HiP247-4 package information

Figure 18. HiP247-4 package outline



8405626_Rev_4

Table 8. HiP247-4 mechanical data

Dim.	mm		
	Min.	Typ.	Max.
A	4.90	5.00	5.10
A1	2.31	2.41	2.51
A2	1.90	2.00	2.10
b	1.16		1.29
b1	1.15	1.20	1.25
b2	0		0.20
c	0.59		0.66
c1	0.58	0.60	0.62
D	20.90	21.00	21.10
D1	16.25	16.55	16.85
D2	1.05	1.20	1.35
D3	24.97	25.12	25.27
E	15.70	15.80	15.90
E1	13.10	13.30	13.50
E2	4.90	5.00	5.10
E3	2.40	2.50	2.60
e	2.44	2.54	2.64
e1	4.98	5.08	5.18
L	19.80	19.92	20.10
P	3.50	3.60	3.70
P1			7.40
P2	2.40	2.50	2.60
Q	5.60		6.00
S		6.15	
T	9.80		10.20
U	6.00		6.40
aaa		0.04	0.10

Revision history

Table 9. Document revision history

Date	Revision	Changes
10-Sep-2024	1	First release.

Contents

1	Electrical ratings	2
2	Electrical characteristics	3
2.1	Electrical characteristics (curves)	5
3	Package information	8
3.1	HiP247-4 package information	8
	Revision history	10

IMPORTANT NOTICE – READ CAREFULLY

STMicroelectronics NV and its subsidiaries (“ST”) reserve the right to make changes, corrections, enhancements, modifications, and improvements to ST products and/or to this document at any time without notice. Purchasers should obtain the latest relevant information on ST products before placing orders. ST products are sold pursuant to ST’s terms and conditions of sale in place at the time of order acknowledgment.

Purchasers are solely responsible for the choice, selection, and use of ST products and ST assumes no liability for application assistance or the design of purchasers’ products.

No license, express or implied, to any intellectual property right is granted by ST herein.

Resale of ST products with provisions different from the information set forth herein shall void any warranty granted by ST for such product.

ST and the ST logo are trademarks of ST. For additional information about ST trademarks, refer to www.st.com/trademarks. All other product or service names are the property of their respective owners.

Information in this document supersedes and replaces information previously supplied in any prior versions of this document.

© 2024 STMicroelectronics – All rights reserved