

Automotive 5000 W TVS in SMC

 SMC
(JEDEC DO-214AB)

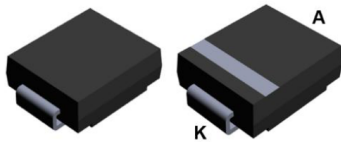
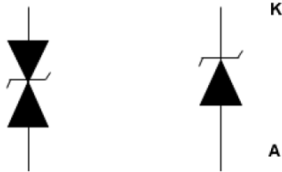

Bidirectional

Unidirectional

Product status link

[SM50T6V8AY](#), [SM50T6V8CAY](#),
[SM50T7V0AY](#), [SM50T7V0CAY](#),
[SM50T7V5AY](#), [SM50T7V5CAY](#),
[SM50T10AY](#), [SM50T10CAY](#),
[SM50T12AY](#), [SM50T12CAY](#),
[SM50T13AY](#), [SM50T13CAY](#),
[SM50T14AY](#), [SM50T14CAY](#),
[SM50T15AY](#), [SM50T15CAY](#),
[SM50T16AY](#), [SM50T16CAY](#),
[SM50T18AY](#), [SM50T18CAY](#),
[SM50T19AY](#), [SM50T19CAY](#),
[SM50T21AY](#), [SM50T21CAY](#),
[SM50T23AY](#), [SM50T23CAY](#),
[SM50T26AY](#), [SM50T26CAY](#),
[SM50T27AY](#), [SM50T27CAY](#),
[SM50T28AY](#), [SM50T28CAY](#),
[SM50T30AY](#), [SM50T30CAY](#),
[SM50T33AY](#), [SM50T33CAY](#),
[SM50T35AY](#), [SM50T35CAY](#),
[SM50T36AY](#), [SM50T36CAY](#),
[SM50T39AY](#), [SM50T39CAY](#),
[SM50T42AY](#), [SM50T42CAY](#),
[SM50T47AY](#), [SM50T47CAY](#),
[SM50T56AY](#), [SM50T56CAY](#),
[SM50T68AY](#), [SM50T68CAY](#),
[SM50T75AY](#), [SM50T75CAY](#),
[SM50T82AY](#), [SM50T82CAY](#),
[SM50T100AY](#), [SM50T100CAY](#),
[SM50T117AY](#), [SM50T117CAY](#)

Features

- AEC-Q101 qualified 
- Peak pulse power:
 - 5000 W (10/1000 μ s)
 - up to 48 kW (8/20 μ s)
- Stand-off voltage range from 5 V to 100 V
- Unidirectional and bidirectional types
- Low leakage current: 0.2 μ A at 25 °C
- Operating T_j max: 175 °C
- JEDEC registered package outline
- Lead finishing: matte tin plating

Complies with the following standards

- UL94, V0
- J-STD-020 MSL level 1
- J-STD-002, JESD 22-B102 E3 and MIL-STD-750, method 2026
- JESD-201 class 2 whisker test
- IPC7531 footprint and JEDEC registered package outline
- IEC 61000-4-4 level 4:
 - 4 k V
- IEC 61000-4-2, C = 150 pF, R = 330 Ω exceeds level 4:
 - 30 kV (air discharge)
 - 30 kV (contact discharge)
- ISO 10605, C = 330 pF, R = 330 Ω :
 - 30 kV (air discharge)
 - 30 kV (contact discharge)
- ISO 7637-2 (not applicable to parts with V_{RM} lower than battery voltage):
 - Pulse 1: $V_S = -150$ V
 - Pulse 2a: $V_S = +112$ V
 - Pulse 3a: $V_S = -220$ V
 - Pulse 3b: $V_S = +150$ V

Description

The SM50TY series are designed to protect sensitive automotive circuits against surges defined in ISO 7637-2 and against electrostatic discharges according to ISO 10605.

SM50TY is suitable for e-breaker and help to comply with ISO 16750.

The Planar technology makes it compatible with high-end circuits where low leakage current and high junction temperature are required to provide long term reliability and stability.

Table 2. Electrical characteristics - parameter values ($T_{amb} = 25\text{ °C}$, unless otherwise specified)

Type	I_{RM} max at V_{RM}			V_{BR} at I_R ⁽¹⁾				10 / 1000 μ s			8 / 20 μ s			αT
								V_{CL} ⁽²⁾⁽³⁾	I_{PP} ⁽⁴⁾	R_D	V_{CL} ⁽²⁾⁽³⁾	I_{PP} ⁽⁴⁾	R_D	
	25 °C	85 °C		Min.	Typ.	Max.		Max.		Max.	Max.		Max.	
	μ A	μ A	V	V	V	V	mA	V	A	m Ω	V	A	m Ω	$10^{-4}/\text{°C}$
SM50T6V8AY/CAY	20	50	5.0	6.4	6.74	7.1	10	9.2	544	3.86	14.4	2136	3.42	5.7
SM50T7V0AY/CAY	20	50	6.0	6.7	7.05	7.4	10	10.3	486	5.97	14.7	2042	3.57	5.9
SM50T7V5AY/CAY	20	50	6.5	7.2	7.58	8	10	11.2	447	7.16	15.2	1986	3.63	6.1
SM50T10AY/CAY	20	50	8.5	9.4	9.9	10.4	1	14.4	348	11.5	18.6	1710	4.80	7.3
SM50T12AY/CAY	0.2	1	10	11.1	11.7	12.3	1	17	295	15.9	21.7	1505	6.25	7.8
SM50T13AY/CAY	0.2	1	11	12.3	13	13.7	1	18	275	15.6	24.2	1387	7.57	8.1
SM50T14AY/CAY	0.2	1	12	13.3	14	14.7	1	19.9	252	20.6	25.3	1309	8.10	8.3
SM50T15AY/CAY	0.2	1	13	14.4	15.2	16	1	21.5	233	23.6	27.2	1227	9.13	8.4
SM50T16AY/CAY	0.2	1	14	15.7	16.5	17.3	1	23.1	216	26.9	29	1151	10.2	8.6
SM50T18AY/CAY	0.2	1	15	16.7	17.6	18.5	1	24.4	205	28.8	32.5	1095	12.8	8.8
SM50T19AY/CAY	0.2	1	16	17.9	18.8	19.8	1	26	192	32.3	34.2	1040	13.8	9.0
SM50T21AY/CAY	0.2	1	18	20	21.1	22.2	1	29.2	171	40.9	39.3	950	18.0	9.2
SM50T23AY/CAY	0.2	1	20	22.2	23.4	24.6	1	32.4	155	50.3	42.8	876	20.8	9.4
SM50T26AY/CAY	0.2	1	22	24.4	25.7	27	1	35.5	141	60.3	48.3	815	26.1	9.6
SM50T27AY/CAY	0.2	1	23	25.7	27	28.4	1	37.8	135	69.6	49.2	784	26.5	9.6
SM50T28AY/CAY	0.2	1	24	26.7	28.1	29.5	1	38.9	129	72.9	50	760	27.0	9.6
SM50T30AY/CAY	0.2	1	26	28.9	30.4	31.9	1	42.1	119	85.7	53.5	715	30.2	9.7
SM50T33AY/CAY	0.2	1	28	31.1	32.7	34.3	1	45.4	110	100.9	59	675	36.6	9.8
SM50T35AY/CAY	0.2	1	30	33.2	35	36.8	1	48.4	103	112.6	64.3	640	43.0	9.9
SM50T36AY/CAY	0.2	1	31	34.2	36	37.8	1	50.2	100	124	65	626	43.5	9.9
SM50T39AY/CAY	0.2	1	33	36.7	38.6	40.5	1	53.3	94	136	69.7	593	49.2	10.0
SM50T42AY/CAY	0.2	1	36	40	42.1	44.2	1	58.1	86	162	76	550	57.8	10.0
SM50T47AY/CAY	0.2	1	40	44.4	46.7	49	1	64.5	78	199	84	511	68.5	10.1
SM50T56AY/CAY	0.2	1	48	53.2	56	58.8	1	77.4	65	286	100	444	92.8	10.3
SM50T68AY/CAY	0.2	1	58	64.6	68	71.4	1	93.6	53	419	121	381	130	10.4
SM50T75AY/CAY	0.2	1	64	71.1	74.8	78.6	1	103	47	519	133	353	154	10.4
SM50T82AY/CAY	0.2	1	70	77.9	82	86.1	1	113	42	640	146	345	174	10.5
SM50T100AY/CAY	0.2	1	85	95	100	105	1	137	32	1000	178	265	275	10.6
SM50T117AY/CAY	0.2	1	100	111	117	123	1	179	28	2000	212	227	392	10.7

1. To calculate V_{BR} versus T_j : V_{BR} at $T_j = V_{BR}$ at $25\text{ °C} \times (1 + \alpha T \times (T_j - 25))$
2. To calculate V_{CL} versus T_j : V_{CL} at $T_j = V_{CL}$ at $25\text{ °C} \times (1 + \alpha T \times (T_j - 25))$
3. To calculate V_{CL} max versus $I_{PPappli}$: $V_{CLmax} = V_{BRmax} + R_D \times I_{PPappli}$
4. Surge capability given for both directions for unidirectional and bidirectional devices

1.1 Characteristics (curves)

Figure 3. Maximum peak power dissipation versus initial junction temperature

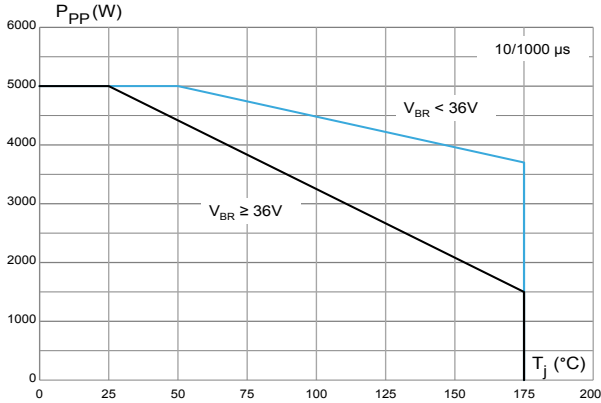

Figure 4. Maximum peak pulse power versus exponential pulse duration

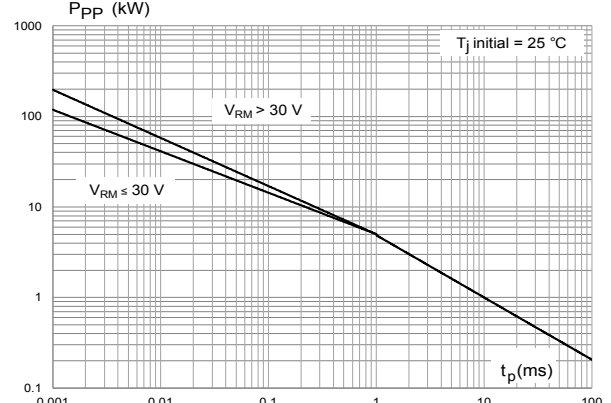

Figure 5. Maximum peak pulse current versus clamping voltage

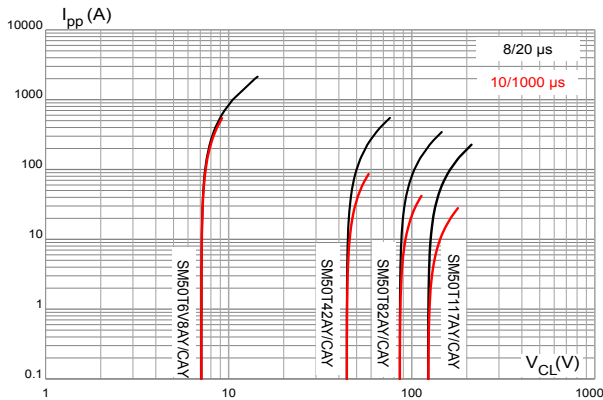

Figure 6. Dynamic resistance versus pulse duration

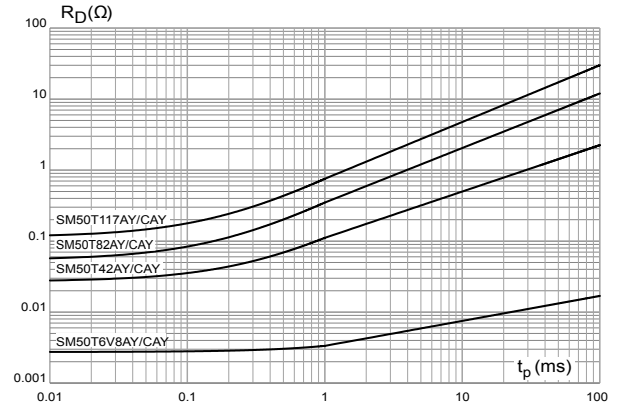

Figure 7. Junction capacitance versus reverse applied voltage (unidirectional type)

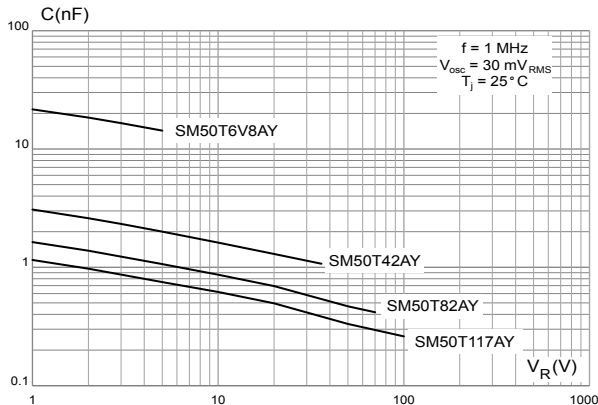

Figure 8. Junction capacitance versus applied voltage (bidirectional type)

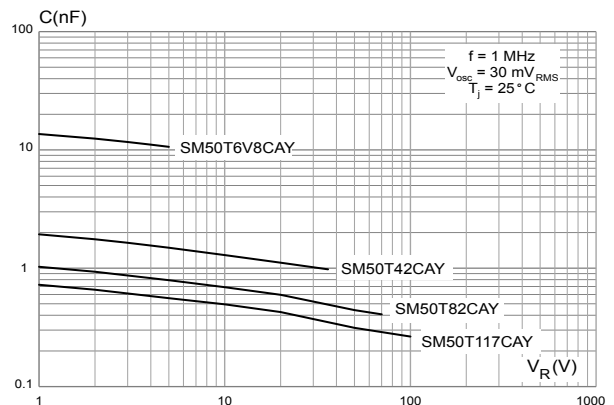

Figure 9. Leakage current versus junction temperature

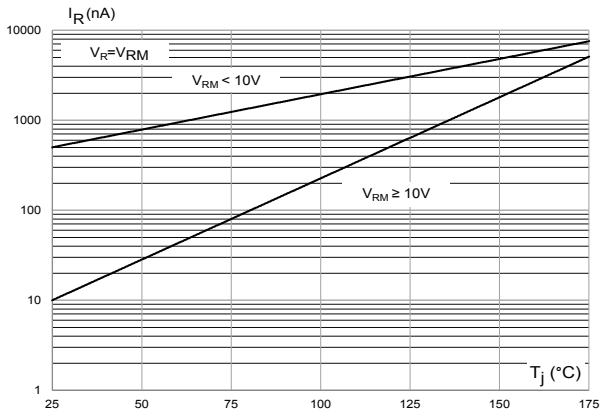

Figure 10. Peak forward voltage drop versus peak forward current

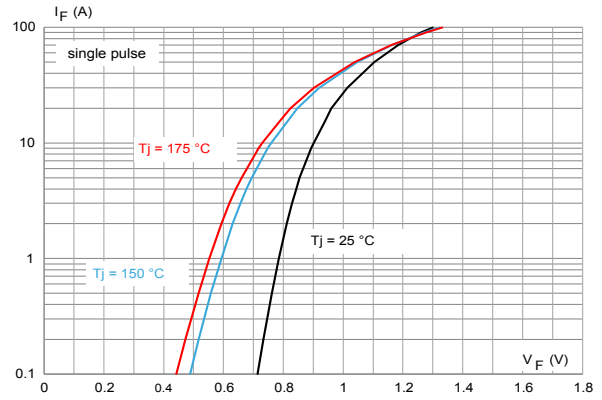

Figure 11. Thermal impedance junction to ambient versus pulse duration

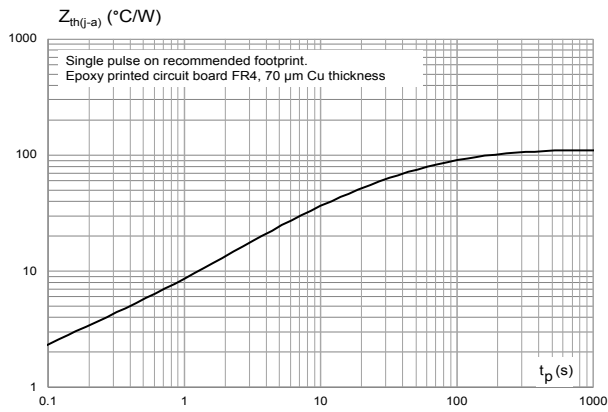

Figure 12. Thermal resistance junction to ambient versus copper area under each lead

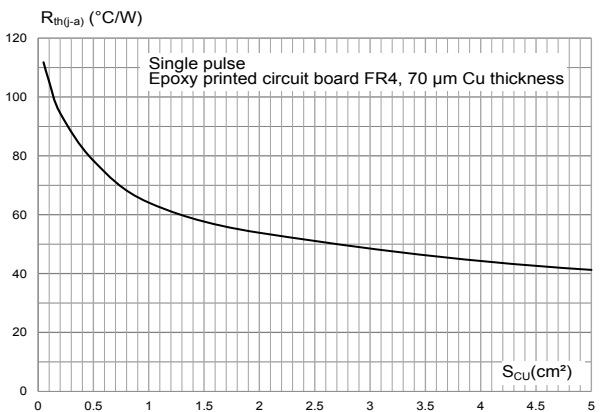

Figure 13. ISO7637-2 pulse 1 response ($V_S = -150\text{ V}$) with 12 V battery

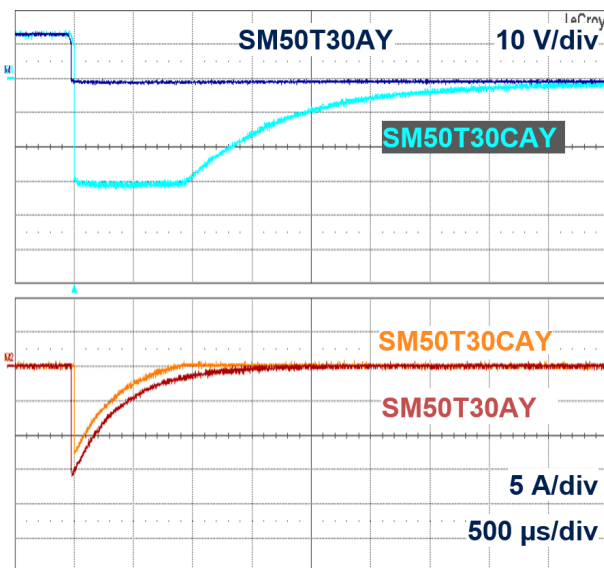

Figure 14. ISO7637-2 pulse 2a response ($V_S = 112\text{ V}$) with 12 V battery

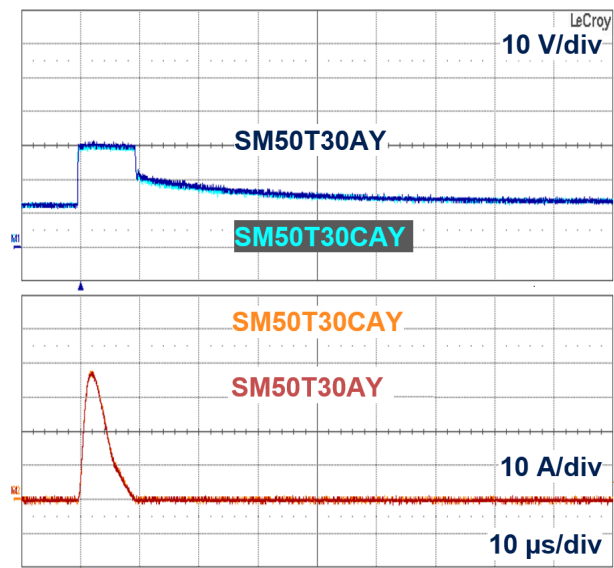

Figure 15. ISO7637-2 pulse 3a response ($V_S = -220\text{ V}$) with 12 V battery

Figure 16. ISO7637-2 pulse 3b response ($V_S = 150\text{ V}$) with 12 V battery

Figure 17. ISO7637-2 pulse 5b definition

Figure 18. Load dump capability ($U_S^* = f(R_i)$ pulse 5b, $U_S = 87\text{ V}$, $t_d = 150\text{ ms}$)

Figure 19. Load dump capability ($U_S^* = f(R_i)$ pulse 5b, $U_S = 87\text{ V}$, $t_d = 400\text{ ms}$)

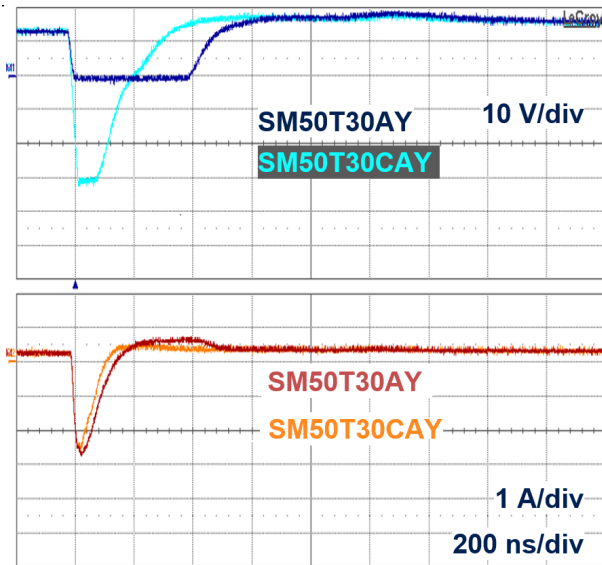
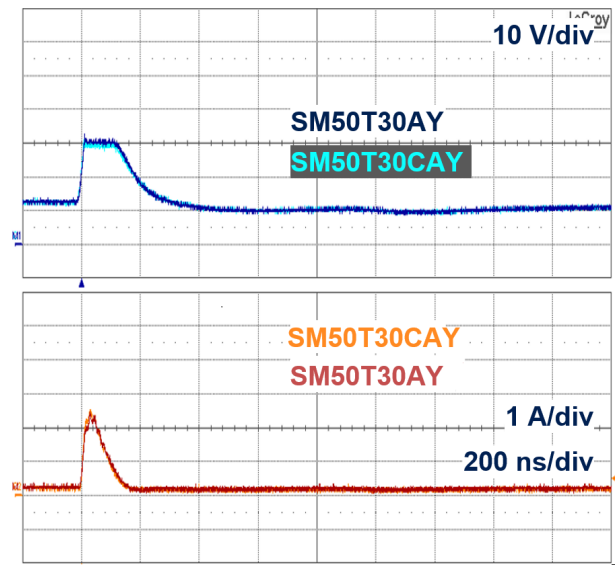
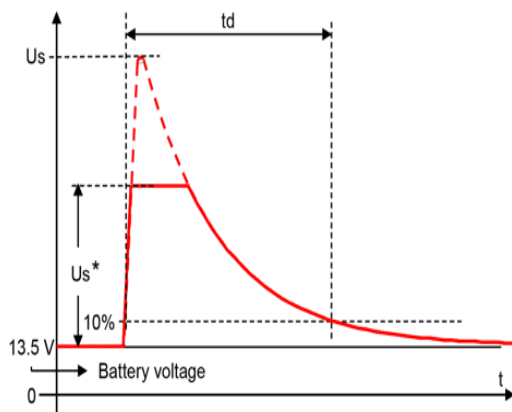
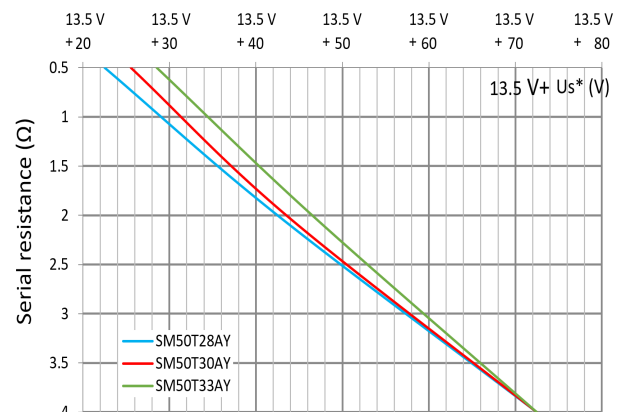
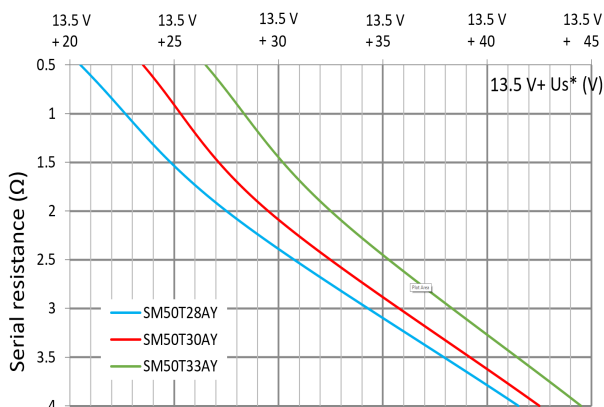
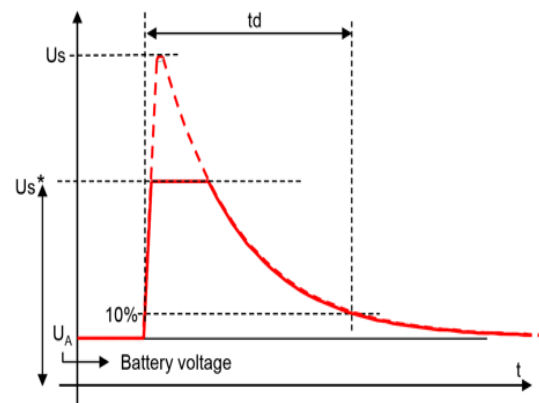
Figure 20. ISO16750-2 test B definition

Figure 21. Load dump capability
($U_s^* = f(R_i)$ test B, $U_s = 87\text{ V}$, $t_d = 150\text{ ms}$)

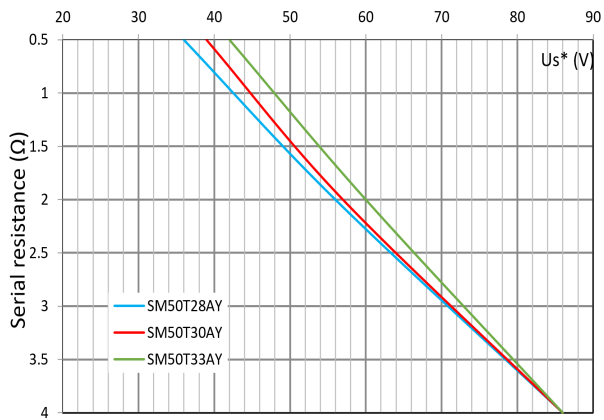
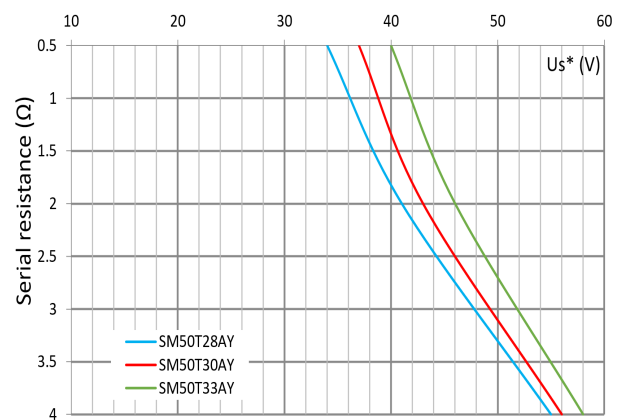

Figure 22. Load dump capability
($U_s^* = f(R_i)$ test B, $U_s = 87\text{ V}$, $t_d = 400\text{ ms}$)



2 Package information

In order to meet environmental requirements, ST offers these devices in different grades of **ECOPACK** packages, depending on their level of environmental compliance. ECOPACK specifications, grade definitions and product status are available at: www.st.com. ECOPACK is an ST trademark.

2.1 SMC package information

Figure 23. SMC package outline

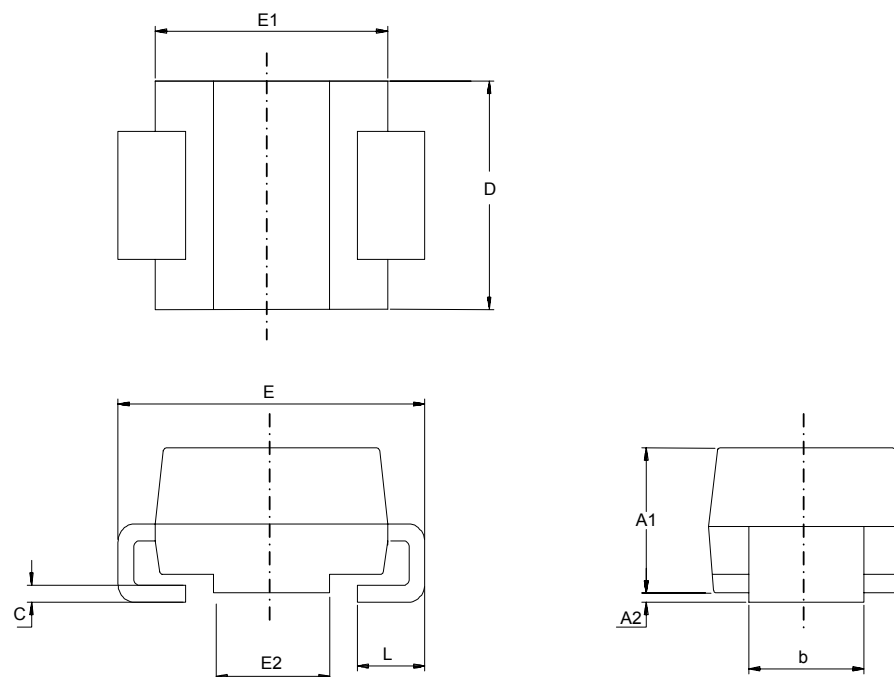

Table 3. SMC package mechanical data

Ref.	Dimensions			
	Millimeters		Inches (for reference only)	
	Min.	Max.	Min.	Max.
A1	1.90	2.45	0.075	0.096
A2	0.05	0.20	0.002	0.008
b	2.90	3.20	0.114	0.126
c	0.15	0.40	0.006	0.016
D	5.55	6.25	0.218	0.246
E	7.75	8.15	0.305	0.321
E1	6.60	7.15	0.260	0.281
E2	4.40	4.70	0.173	0.185
L	0.75	1.50	0.030	0.060

Figure 24. Footprint recommendation

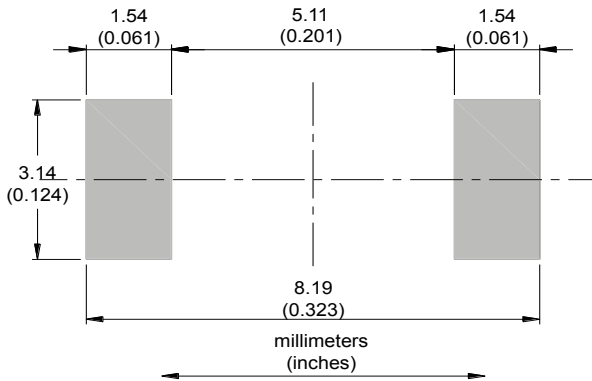

Figure 25. Marking layout

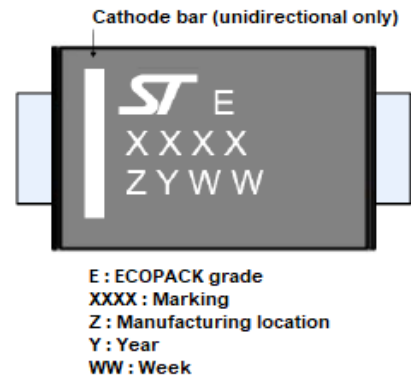
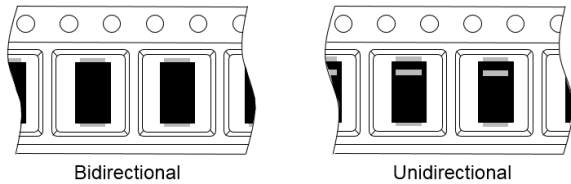

Figure 26. Package orientation in reel



Taped according to EIA-481
Pocket dimensions are not on scale.
Pocket shape may vary depending on package
On bidirectional devices, marking and logo may not be always in the same direction.

Figure 27. Tape and reel orientation

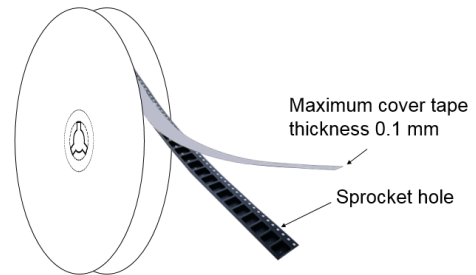

Figure 28. 13" reel dimension values (mm)

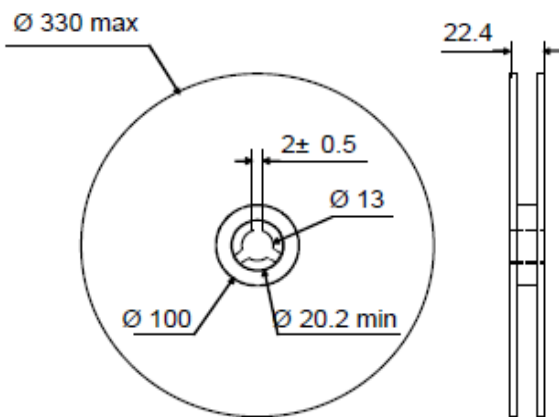

Figure 29. Inner box dimension values (mm)

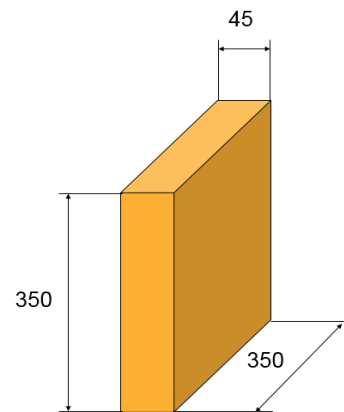
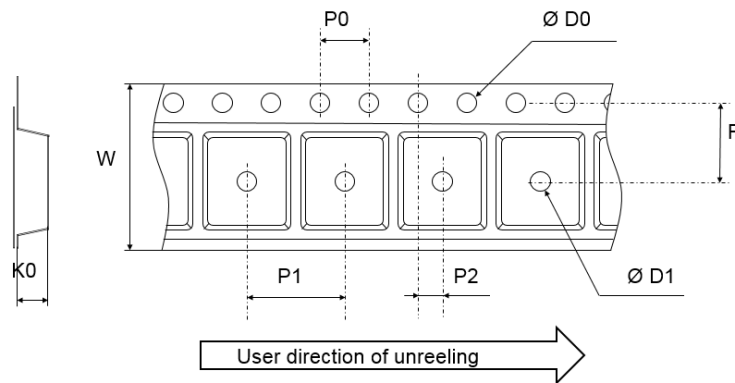

Figure 30. Tape outline



Note: Pocket dimensions are not on scale
Pocket shape may vary depending on package

Table 4. Tape dimension values

Ref.	Dimensions		
	Millimeters		
	Min.	Typ.	Max.
D0	1.4	1.5	1.6
D1	1.5		
F	7.4	7.5	7.6
K0	2.39	2.49	2.59
P0	3.9	4.0	4.1
P1	7.9	8.0	8.1
P2	1.9	2.0	2.1
W	15.7	16	16.3

2.2 Reflow profile

Figure 31. ST ECOPACK recommended soldering reflow profile for PCB mounting

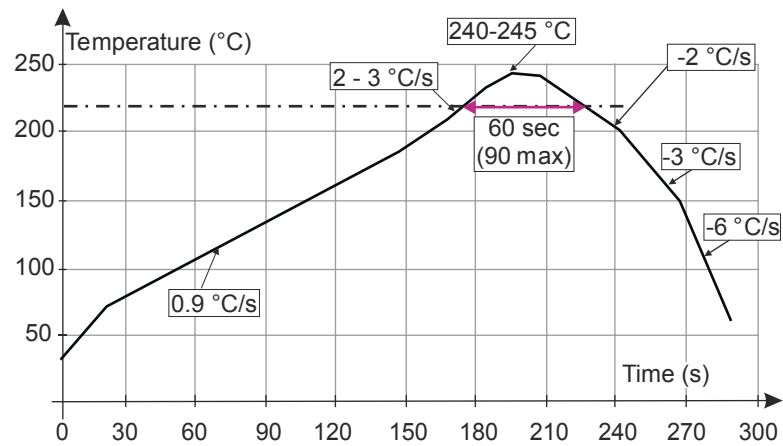

Note: Minimize air convection currents in the reflow oven to avoid component movement. Maximum soldering profile corresponds to the latest IPC/JEDEC J-STD-020.

3 Application and design guidelines

More information is available in the application note AN2689 “Protection of automotive electronics from electrical hazards, guidelines for design and component selection”.

4 Ordering information

Table 5. Ordering information

Order code	Marking	Package	Weight	Base qty.	Delivery mode
SM50TxxAY/CAY ⁽¹⁾	See Table 6. Marking.	SMC	264 mg	2500	Tape and reel

1. Where xx is nominal value of V_{BR} and A or CA indicates unidirectional or bidirectional version.

Table 6. Marking

Order code	Marking	Order code	Marking
SM50T6V8AY	EAIY	SM50T6V8CAY	EAIY
SM50T7V0AY	EAKY	SM50T7V0CAY	EAKY
SM50T7V5AY	EALY	SM50T7V5CAY	EALY
SM50T10AY	EAPY	SM50T10CAY	EAPY
SM50T12AY	EASY	SM50T12CAY	EASY
SM50T13AY	EAUY	SM50T13CAY	EAUY
SM50T14AY	EAWY	SM50T14CAY	EAWY
SM50T15AY	EAYY	SM50T15CAY	EAYY
SM50T16AY	EBAY	SM50T16CAY	EBAY
SM50T18AY	EBCY	SM50T18CAY	EBCY
SM50T19AY	EBEY	SM50T19CAY	EBEY
SM50T21AY	EBIY	SM50T21CAY	EBIY
SM50T23AY	EBMY	SM50T23CAY	EBMY
SM50T26AY	EBOY	SM50T26CAY	EBOY
SM50T27AY	EBPY	SM50T27CAY	EBPY
SM50T28AY	EBQY	SM50T28CAY	EBQY
SM50T30AY	EBSY	SM50T30CAY	EBSY
SM50T33AY	EBUY	SM50T33CAY	EBUY
SM50T35AY	EBWY	SM50T35CAY	EBWY
SM50T36AY	EBXY	SM50T36CAY	EBXY
SM50T39AY	EBZY	SM50T39CAY	EBZY
SM50T42AY	ECCY	SM50T42CAY	ECCY
SM50T47AY	ECGY	SM50T47CAY	ECGY
SM50T56AY	ECOY	SM50T56CAY	ECOY
SM50T68AY	ECYY	SM50T68CAY	ECYY
SM50T75AY	EDEY	SM50T75CAY	EDEY
SM50T82AY	EDKY	SM50T82CAY	EDKY
SM50T100AY	EDZY	SM50T100CAY	EDZY
SM50T117AY	EEOY	SM50T117CAY	EEOY

Note: Marking differentiation between unidirectional and bidirectional devices is done with cathode bar.

Revision history

Table 7. Document revision history

Date	Revision	Changes
07-Nov-2022	1	Initial release.
22-Nov-2022	2	Updated Table 2 for typo errors.

IMPORTANT NOTICE – READ CAREFULLY

STMicroelectronics NV and its subsidiaries (“ST”) reserve the right to make changes, corrections, enhancements, modifications, and improvements to ST products and/or to this document at any time without notice. Purchasers should obtain the latest relevant information on ST products before placing orders. ST products are sold pursuant to ST’s terms and conditions of sale in place at the time of order acknowledgment.

Purchasers are solely responsible for the choice, selection, and use of ST products and ST assumes no liability for application assistance or the design of purchasers’ products.

No license, express or implied, to any intellectual property right is granted by ST herein.

Resale of ST products with provisions different from the information set forth herein shall void any warranty granted by ST for such product.

ST and the ST logo are trademarks of ST. For additional information about ST trademarks, refer to www.st.com/trademarks. All other product or service names are the property of their respective owners.

Information in this document supersedes and replaces information previously supplied in any prior versions of this document.

© 2022 STMicroelectronics – All rights reserved