

### Introduction

This user manual describes the demonstration firmware running on the STM3220G-EVAL (Rev. B) evaluation board, which can be used to evaluate the capabilities of the STM32F2xx microcontrollers and on-board peripherals. The demonstration firmware also runs on the STM3221G-EVAL evaluation board.

In case the STM3220G-EVAL board was not factory-programmed or the demonstration application was erased, it can be re-programmed by following the steps described in [Chapter 3: Programming the demonstration](#).

The STM3220G-EVAL board comes with a USB Flash disk preprogrammed with audio and images resources used by the demonstration. You can load your own image (\*.bmp) and audio (\*.wav) files provided that the file formats are supported by the demonstration firmware.

For more details, please refer to [Section 2.5: Image browser](#) and [Section 2.8: Audio player](#). The default audio files available in the USB Flash disk are based on free music downloads from the DanoSongs.com website. This demonstration firmware is available for download from the STMicroelectronics website at [www.st.com](http://www.st.com).

**Figure 1. STM3220G-EVAL demonstration application**

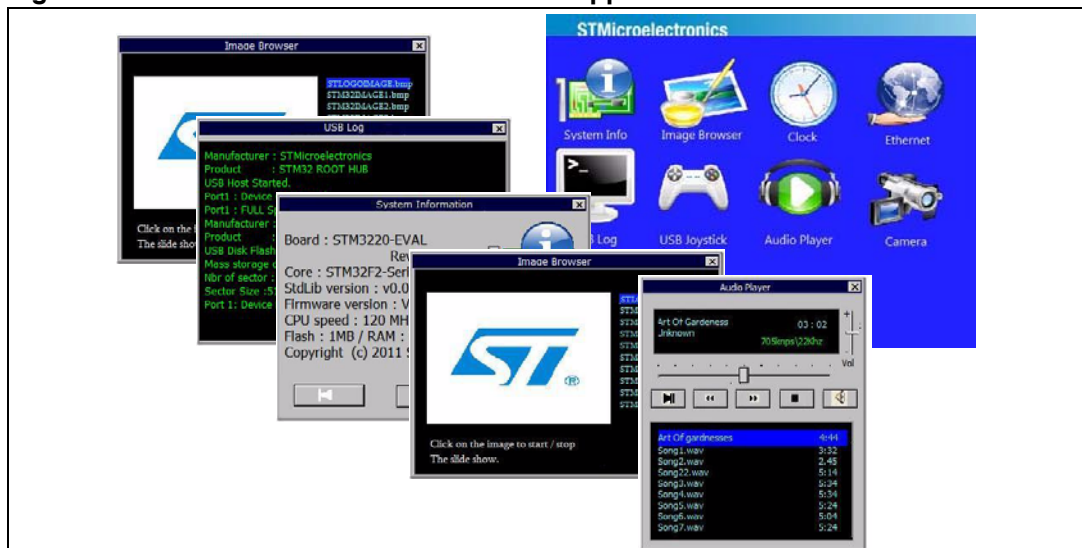

[Table 1](#) lists the development tools concerned by this user manual.

**Table 1. Applicable tools**

Type	Applicable tools
Development tools	STM3220G-EVAL, STM3221G-EVAL

# Contents

- 1      Demonstration architecture overview ..... 5**
  - 1.1    Hardware resources ..... 5
  - 1.2    Hardware configuration ..... 6
    - 1.2.1    Required accessories ..... 6
    - 1.2.2    Jumper configurations ..... 7
  - 1.3    Firmware architecture ..... 7
  
- 2      Demonstration architecture overview ..... 9**
  - 2.1    Navigation procedure ..... 9
  - 2.2    Demo startup ..... 9
  - 2.3    USB console ..... 10
  - 2.4    System info ..... 10
  - 2.5    Image browser ..... 11
  - 2.6    Web server ..... 12
  - 2.7    USB joystick ..... 15
  - 2.8    Audio player ..... 16
  - 2.9    Analog clock ..... 17
  - 2.10   Camera ..... 18
  - 2.11   Sub-demo interaction ..... 18
  
- 3      Programming the demonstration ..... 19**
  
- 4      Revision history ..... 20**

## List of tables

Table 1.	Applicable products and tools . . . . .	1
Table 2.	Jumper configurations . . . . .	7
Table 3.	Supported bitmap formats . . . . .	12
Table 4.	Audio file configurations . . . . .	16
Table 5.	Document revision history . . . . .	20

## List of figures

Figure 1.	STM3220G-EVAL demonstration application . . . . .	1
Figure 2.	Hardware block diagram . . . . .	5
Figure 3.	Hardware configuration . . . . .	6
Figure 4.	USB Flash disk tree structure . . . . .	6
Figure 5.	Firmware architecture . . . . .	7
Figure 6.	Startup screen during initialization phase . . . . .	9
Figure 7.	Main desktop (icon view widget) . . . . .	9
Figure 8.	USB console frame window . . . . .	10
Figure 9.	First frame window . . . . .	10
Figure 10.	Second frame window . . . . .	11
Figure 11.	Third frame window . . . . .	11
Figure 12.	Image browser . . . . .	11
Figure 13.	Web server DHCP server reply . . . . .	12
Figure 14.	Connection properties screen . . . . .	13
Figure 15.	TCP/IP properties screen . . . . .	13
Figure 16.	Connection status screen . . . . .	14
Figure 17.	HID properties screen . . . . .	15
Figure 18.	USB joystick status screen . . . . .	15
Figure 19.	Audio player diagram . . . . .	16
Figure 20.	Audio player interface . . . . .	16
Figure 21.	Analog clock window . . . . .	17
Figure 22.	Analog clock configuration window . . . . .	17
Figure 23.	Analog clock date and time format . . . . .	17
Figure 24.	Analog clock error message . . . . .	17
Figure 25.	Camera diagram . . . . .	18
Figure 26.	Capture screen . . . . .	18

# 1 Demonstration architecture overview

## 1.1 Hardware resources

The demonstration firmware mainly uses the following two peripherals which are major features of the STM32F2xx device:

- Ethernet (web server)
- USB on-the-go: the USB OTG Full Speed (FS) is used in Host mode for audio and image media storage while the USB OTG High Speed (HS) is used for the USB Human Interface Device (HID) applications

The firmware makes use of other STM32 peripherals for demonstration purposes:

- User interface: color display, LEDs, event input (keys, touch screen)
- I2S IP for the audio (.wav file) player
- Digital camera interface (DCMI) for the camera application
- RTC IP for the clock application

Other STM32 hardware features are used globally by the demonstration application and the software environment (for example, the SysTick timer for the real-time operating system (RTOS), the I<sup>2</sup>C for the IO expander used by the touch screen, etc.).

The camera application also uses the SRAM embedded on the STM3220G-EVAL board to store the camera frames via the DMA before they are output to the display through the GUI.

Figure 2. Hardware block diagram

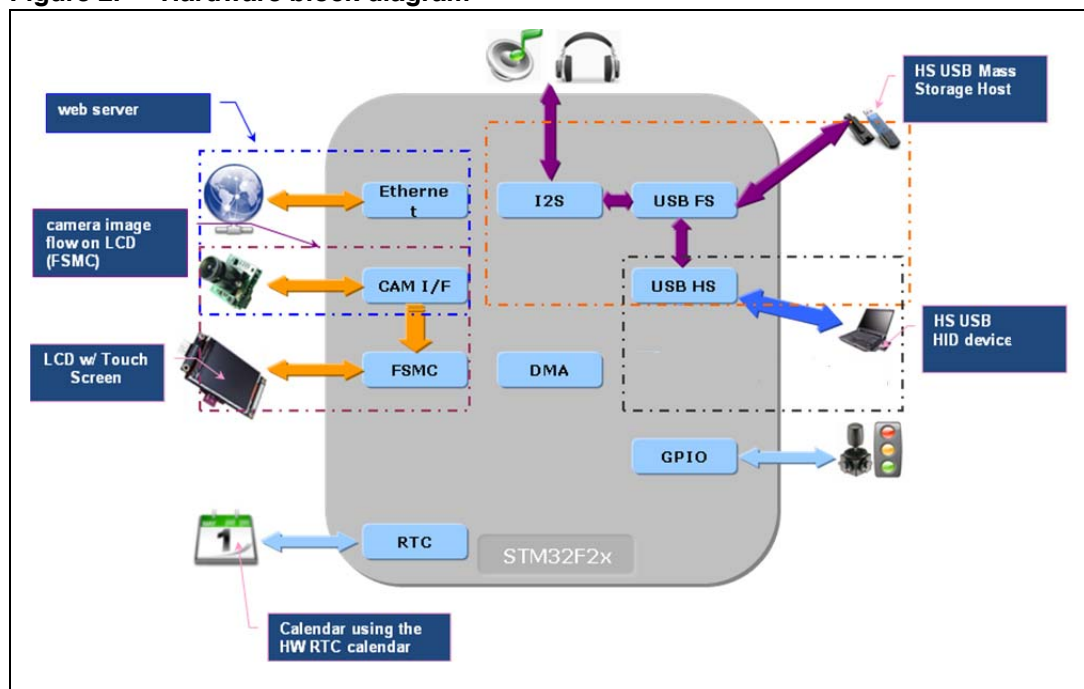

## 1.2 Hardware configuration

Figure 3. Hardware configuration

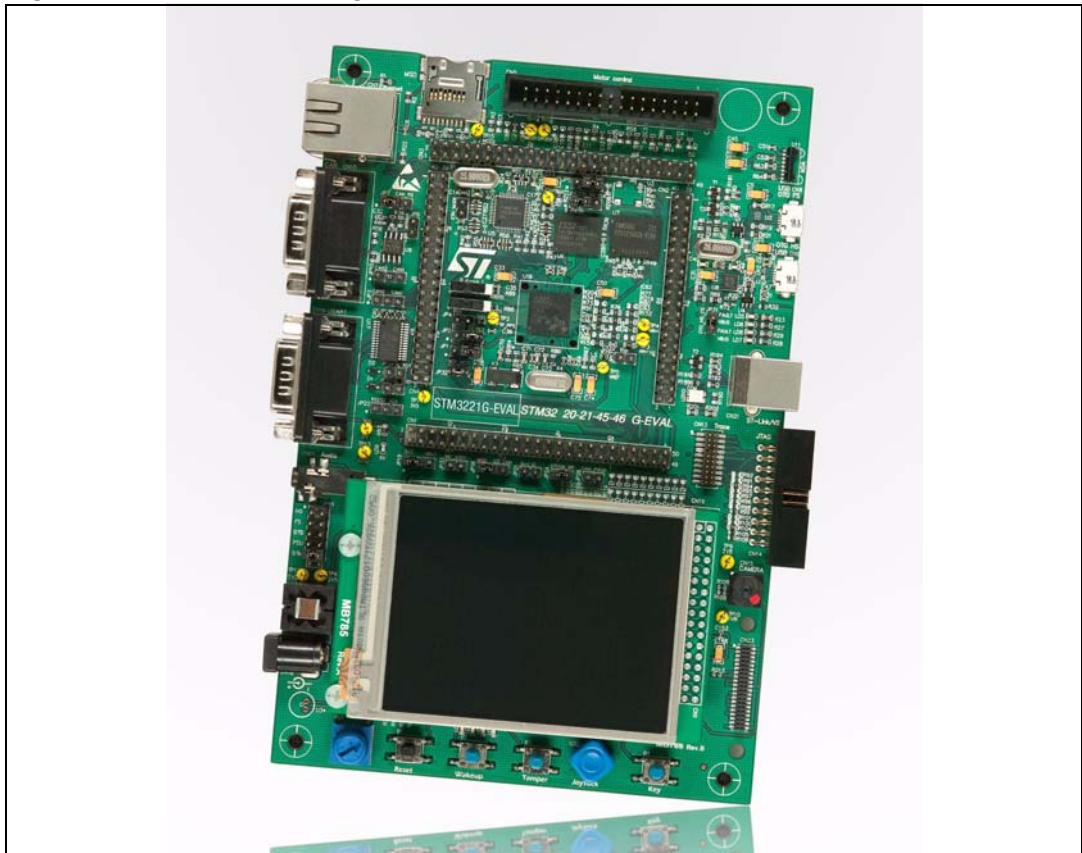

### 1.2.1 Required accessories

In addition to the STM3220G-EVAL board, the demonstration requires the following accessories:

- Micro-AB to standard receptacle A connector (provided with STM3220G-EVAL board package)
- Micro-AB to standard plug A connector (provided with STM3220G-EVAL board package)
- Headphone with male jack connector
- USB Flash disk (provided with STM3220G-EVAL board package)

Figure 4. USB Flash disk tree structure



### 1.2.2 Jumper configurations

Table 2. Jumper configurations

Jumper	Usage	Configuration	Note
JP5	Ethernet	2 <-> 3	25 MHz clock provided by MCO
JP6	Ethernet	2 <->3	MII interface mode is enabled
JP8	Ethernet	Open	MII interface mode is enabled
JP19	RTC	2 <-> 3	RTC powered by embedded battery
JP31	USB OTG HS	Fitted	USB OTG HS selected
SW1	Boot mode	1 <-> 2	STM3220G-EVAL boot from User Flash
SW1	Boot mode	1 <-> 2	STM3220G-EVAL boot from User Flash

### 1.3 Firmware architecture

The demonstration is built with a modular architecture based on a real time operating system and uses a graphical windowing system based on the uC-OSII RTOS from Micrium and the emWin graphical stack from Segger.

The system configuration and the standard peripheral settings and configuration are made through the STM32F2xx Standard Peripheral Library.

Data used by the application is stored in the external USB Flash disk through a FAT file system (emFile from Segger) in order to save space in the STM32 internal Flash memory.

Figure 5. Firmware architecture

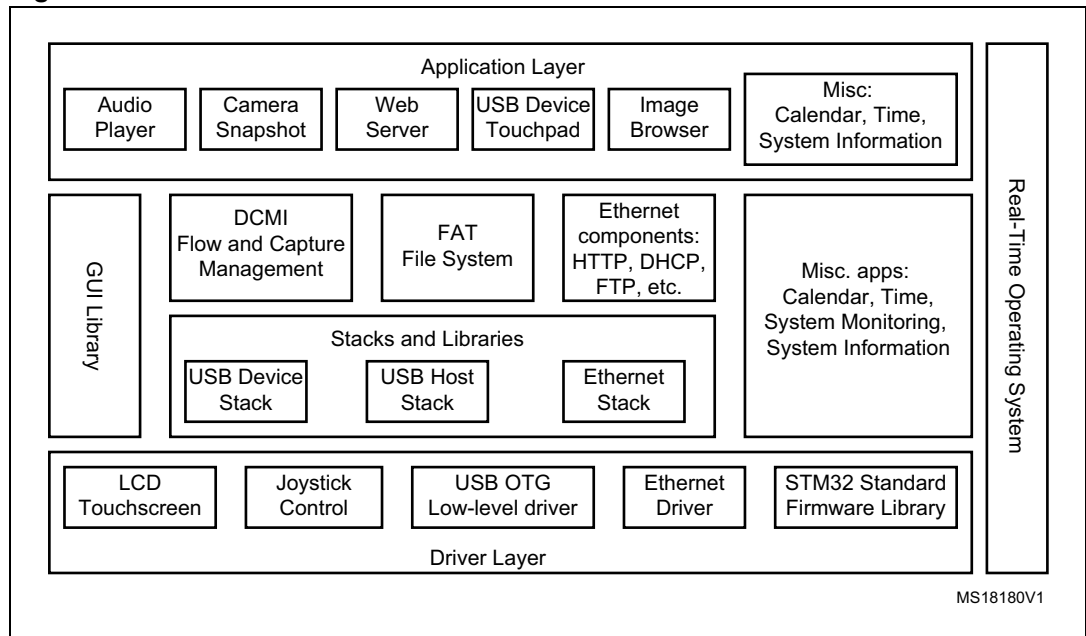

The demonstration application is built using the following software components:

1. STM32F2xx Standard Peripheral Library V1.0.0
2.  $\mu$ C-OSII RTOS (Version 2.86)
3.  $\mu$ C-USB Host stack (Version 3.0)
4. emWin Graphical stack (Version 3.10)
5. emFile file system (Version 4.16 from Segger)
6. LwIP TCP/IP stack (Version1.3.1)



## 2 Demonstration architecture overview

The STM3220G-EVAL demonstration consists of seven sub-demos and uses the emWin graphical stack for the visual aspect, uC-Host stack and uC-FS for media storage in the connected USB Flash disk; the embedded touch screen is used as an input device (one touch mode) and the LCD is used in 16-bit color mode.

### 2.1 Navigation procedure

The STM3220G-EVAL demonstration is an interactive application; the navigation within sub-demos is done by a single touch using a pen or finger on the active touch screen.

### 2.2 Demo startup

The application starts in text mode until the initialization phase is completed.

**Figure 6. Startup screen during initialization phase**

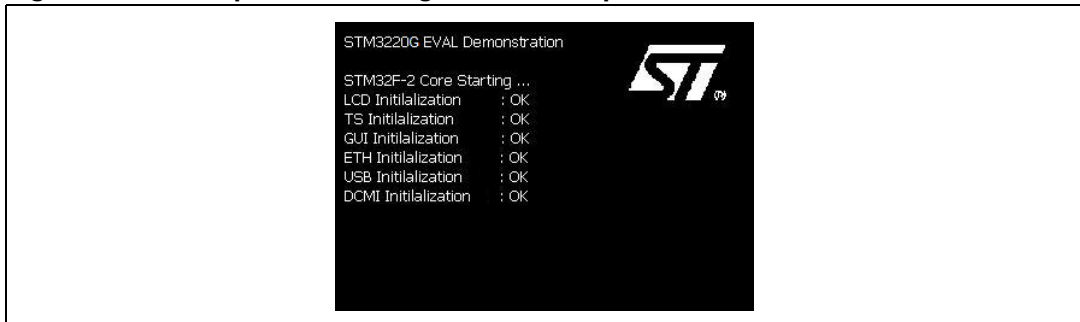

After initializing the hardware, the involved peripherals and the GUI stacks, the main desktop displays all the available sub-demos through the icon view widget.

**Figure 7. Main desktop (icon view widget)**



### 2.3 USB console

The USB console frame window shows the USB Host connectivity state. The *USB Disk Flash Connected* message means that the USB Flash disk is configured and ready for use.

**Figure 8. USB console frame window**

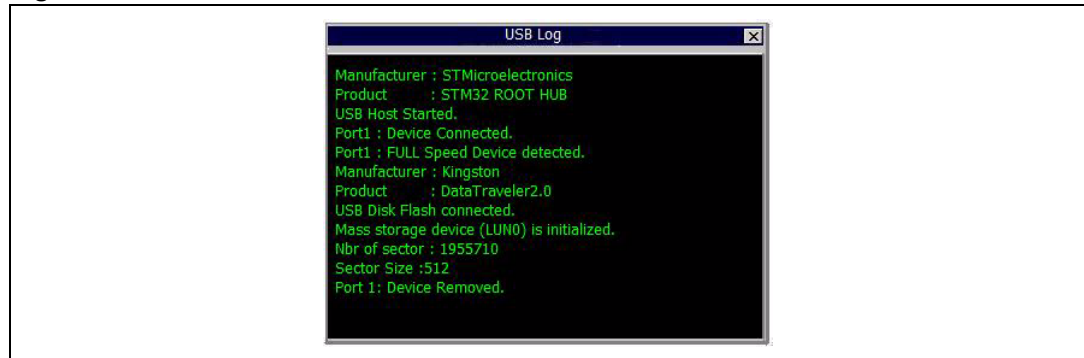

### 2.4 System info

The system info sub-demo is composed of three window frames. The user can use the forward and back buttons to navigate within the three windows while the Exit button ends the sub-demo and displays the main menu (Icon view).

The first frame window ([Figure 9](#)) shows the hardware and software revisions and the STM32 hardware resources (RAM and Flash size).

**Figure 9. First frame window**

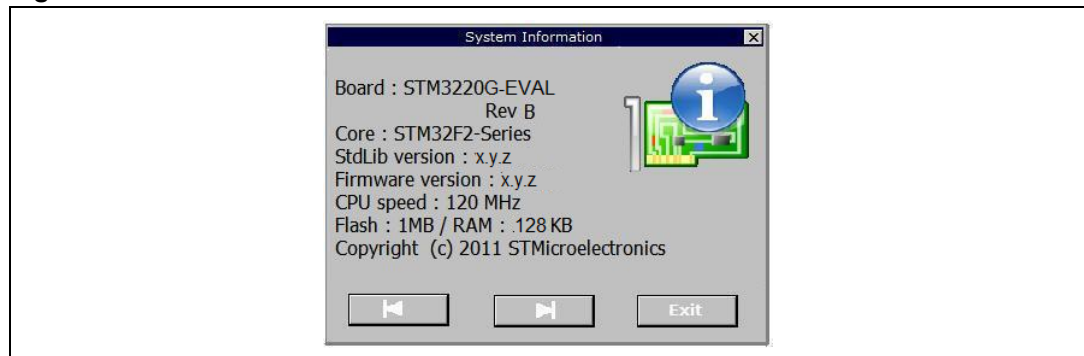

The second frame window (*Figure 10*) indicates the instant CPU usage in percentage (%); the graphical widget is updated every second.

**Figure 10. Second frame window**

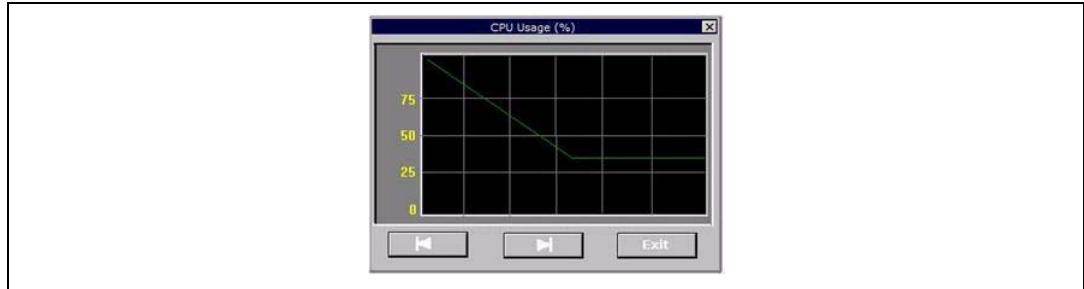

The third frame window (*Figure 11*) shows the different priorities and memory usage of the running tasks.

**Figure 11. Third frame window**

Task Name	Prio	Mem [B]
USBH_AsynchThread	02	0152
Gui Task	04	1864
Input Event	05	0148
Start	06	0672
USBH_Event	07	0984
uC/COSII-Stat	30	0140
uC/COSII-Idle	31	0072

The task list is arranged by priority order; the user can click on the Prio tab to invert the order of the priorities. The memory usage is given in bytes and corresponds to the internal stack size of the corresponding running task.

*Note:* The task list is not updated dynamically when a new sub-demo is launched; the user should exit and launch again the task window by using the forward and back buttons to update the list of tasks.

## 2.5 Image browser

The Image browser displays the bitmap (BMP) files stored in the “Images” directory from the connected USB Flash disk (connected to the USB OTG FS port). The Image browser automatically resizes the image to fit in the display area.

**Figure 12. Image browser**



The user can enable/disable the automatic slide show by clicking on the picture; when the automatic slide show is enabled, the images are changed every second.

The user can also select the image to show from the list displayed in the right of the Image browser window frame.

Table 3 shows the different supported BMP formats.

**Table 3. Supported bitmap formats**

Bits per pixel	Indexed	Compression	Supported
1	Yes	No	Yes
4	Yes	No	Yes
4	Yes	Yes	Yes
8	Yes	No	Yes
8	Yes	Yes	Yes
16	No	No	Yes
24	No	No	Yes
32	No	No	Yes

## 2.6 Web server

This demonstration is an embedded web server based on the lwIP stack. It allows addressing the STM3220G-EVAL board as a web page using your web browser to control the four LEDs on the board and the potentiometer level.

The STM32 Ethernet peripheral is configured in MII mode with speed auto negotiation and the Clock for the external PHY is provided by the STM32 through the MCO pin.

**Figure 13. Web server DHCP server reply**



The web server sub-demo supports the DHCP protocol and, if the DHCP is enabled in the host side, an automatic IP address is assigned to the board; otherwise, a static IP address is used instead (192.168.0.8).

## How to use the web server demonstration

1. Ensure that the jumper configuration on your STM3220G-EVAL board is correct (refer to [Table 2: Jumper configurations on page 7](#)).
2. Modify your PC network configuration:
  - a) Disable the Internet firewall installed on your PC (if it is enabled) and bypass/deselect any proxy server in use.
  - b) Set your PC network card “Speed & Duplex” property to “**Auto Navigation**”: under Windows, select **Control Panel > Network Connections > Local Area Connection > Properties > Configure > Advanced > Speed & Duplex**.

**Figure 14. Connection properties screen**

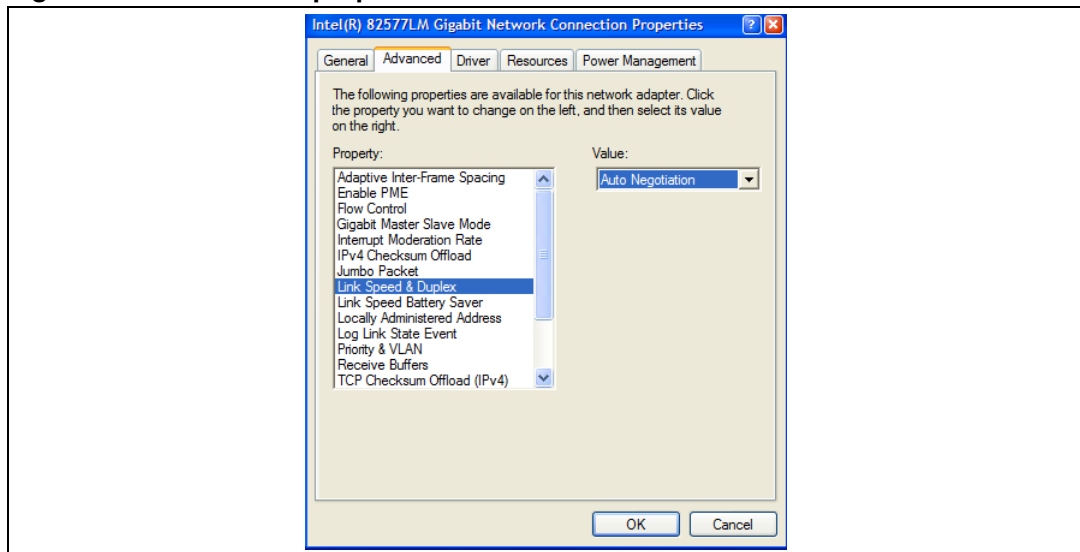

- c) If the DHCP is not supported, change your PC IP address to 192.168.0.x (x different from 8). To do this, under Windows, select **Control Panel > Network Connections > Local Area Connection > Properties > Internet Protocol (TCP/IP) > Properties** > and use the following IP address.

**Figure 15. TCP/IP properties screen**

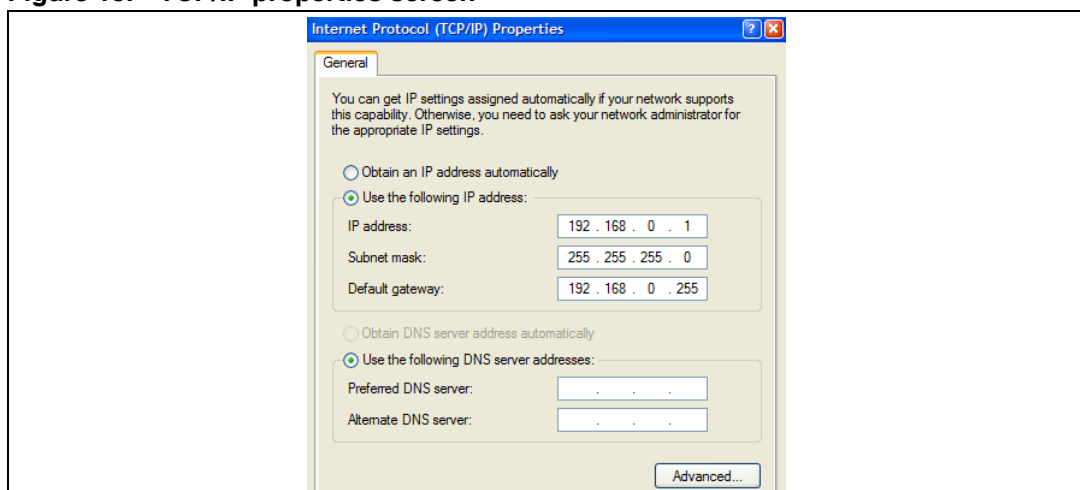

- d) If the DHCP is supported, enable the DHCP and the STM3220G-EVAL board will automatically acquire an IP address.

**Figure 16. Connection status screen**

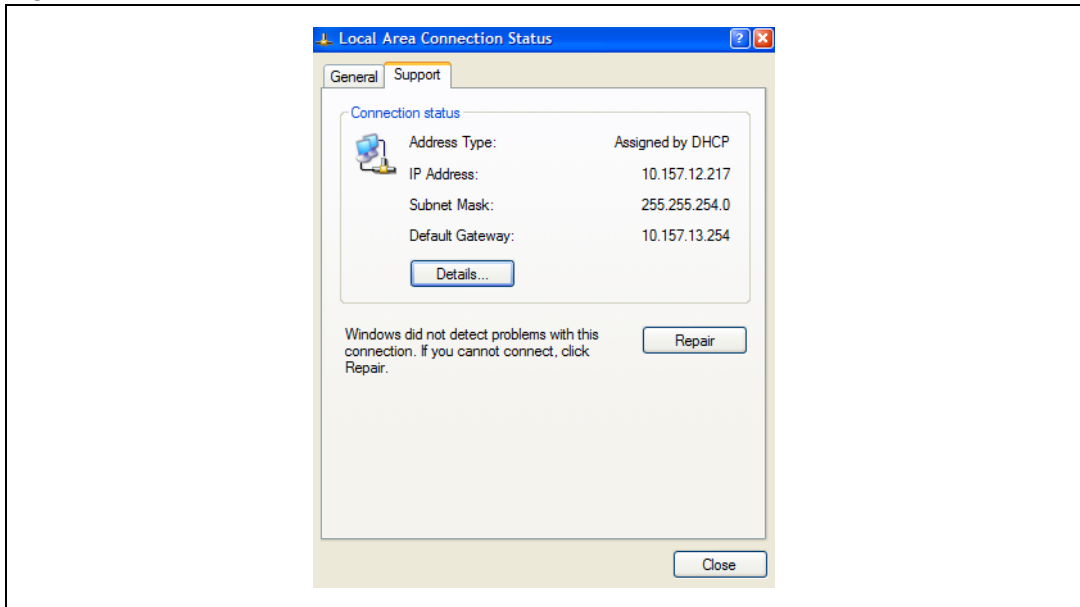

3. In point-to-point configuration, connect your PC to the STM3220G-EVAL board using an Ethernet cross cable.
4. In a local network, connect the STM3220G-EVAL board to the network hub using an Ethernet regular cable.
5. Ping the board by typing in the DOS command window: “ping xx.xx.xx.xx” where xx.xx.xx.xx is the DHCP or the statically assigned IP address.
6. In your internet browser, type “http:// xx.xx.xx.xx” to load the STM32 web page.
7. Now you can turn on/off the four LEDs on the STM3220G-EVAL board.

## 2.7 USB joystick

The HID example uses the joystick embedded in the STM3220G-EVAL evaluation board. The HID example works in High Speed mode (the USB OTG HS connector is used).

**Figure 17. HID properties screen**

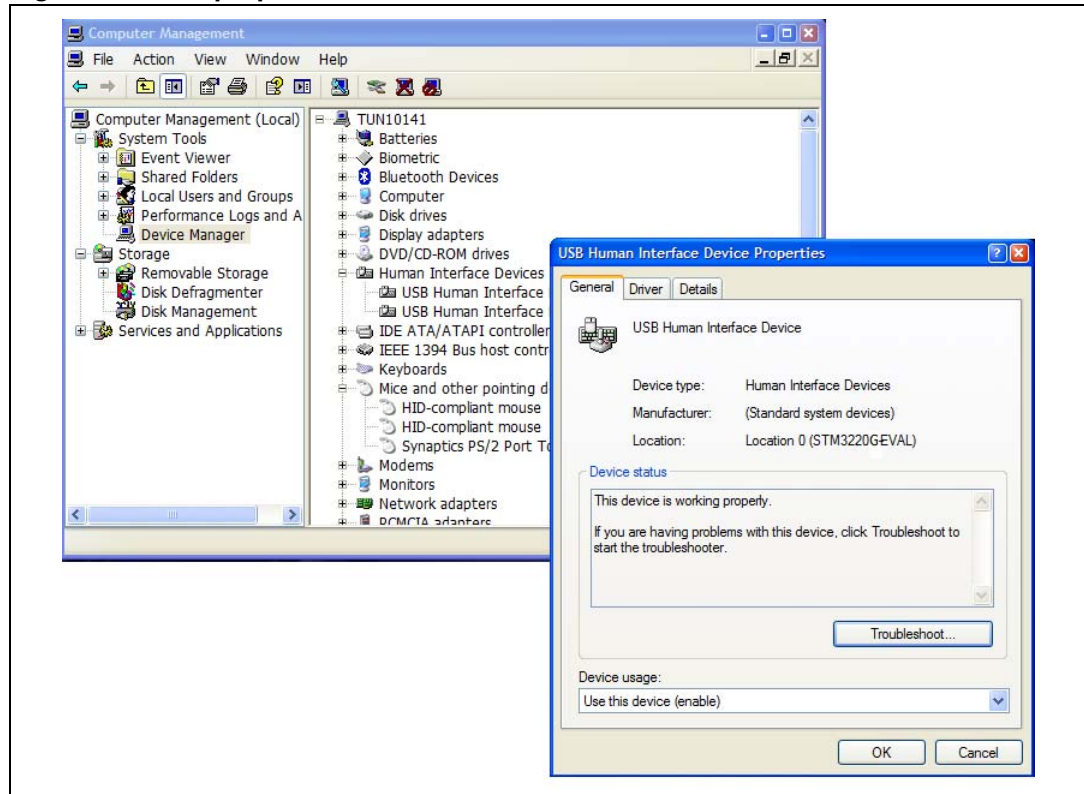

Once connected and correctly configured, the STM3220G-EVAL board acts as a USB HID joystick device and the user can move the mouse pointer on the Host by using the Up, Left, Down and Right buttons.

**Figure 18. USB joystick status screen**

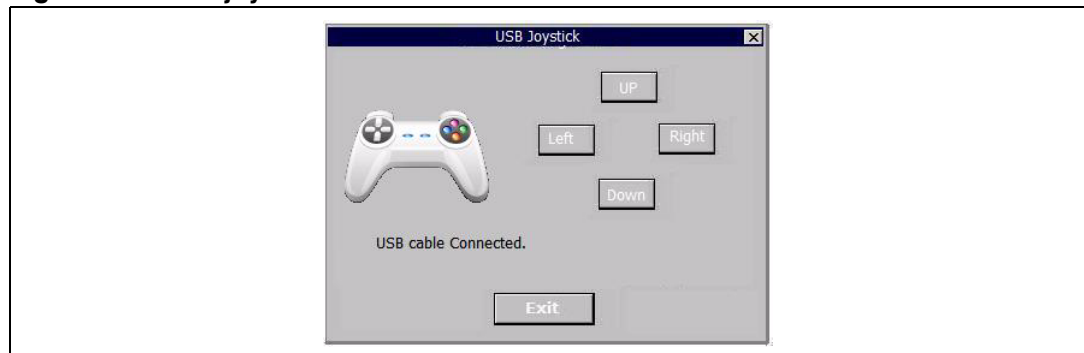

## 2.8 Audio player

The audio player retrieves the WAV files stored in the “Audio” directory in the connected USB Flash disk (connected to the USB OTG FS port).

**Figure 19. Audio player diagram**

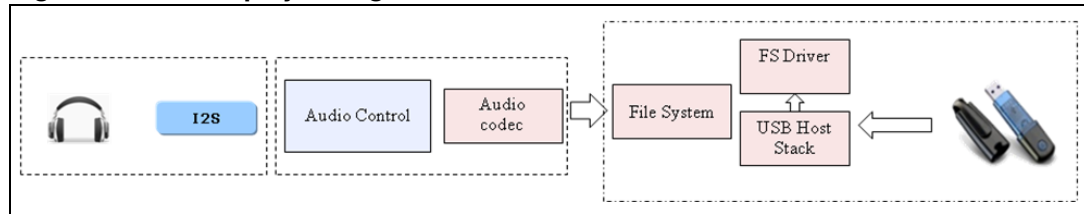

The user can Stop/Play/Resume/Go Back/ Forward and Mute the audio sample and can select the title to be played directly from the playlist.

**Figure 20. Audio player interface**

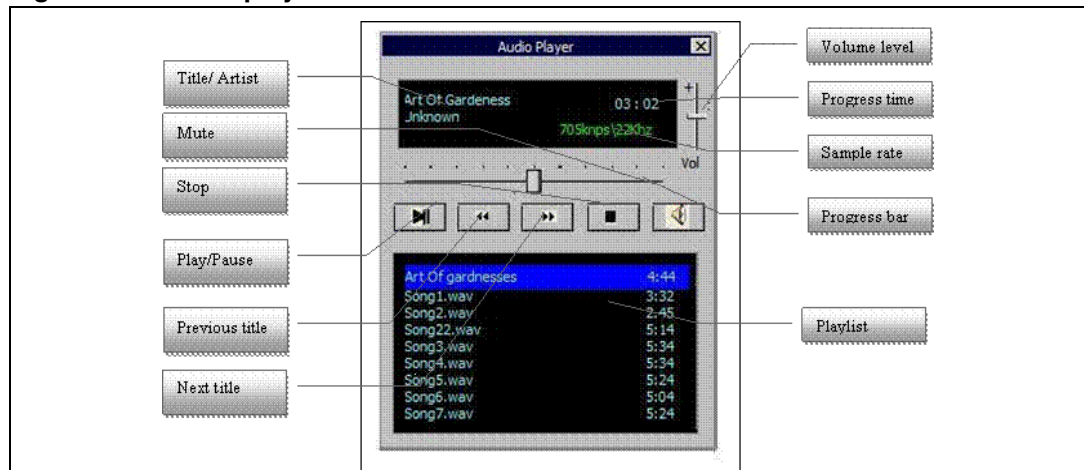

The user can use a headset or the embedded speaker to output the audio sample. The peripheral is detected automatically: when the headset is removed, the speaker is automatically used. The audio player supports all WAV PCM audio files with the configuration listed in [Table 4](#).

**Table 4. Audio file configurations**

Parameter	Value
Sample rate	8 to 96 kHz
Channel number	Stereo/Mono
Audio Data Format	16 bits

*Note:* This limitation is due to the audio codec used on the STM3220G-EVAL board which accepts a fixed Master Clock frequency while the STM32F2xx I2S provides a Master clock at a fixed rate of  $256 \times f_S$  (where  $f_S$  is the audio sampling rate). It is recommended to use the headset when listening to audio files with a sample rate below 32 Hz, and use a headset or speaker for other audio files.



## 2.9 Analog clock

The analog clock window shows the system clock (RTC) on an analog background, and also the current date on the caption of the frame window.

**Figure 21. Analog clock window**



To configure the clock and the date, the user can click the Set button to display a second frame window with a numerical pad used to easily set the clock and the date.

**Figure 22. Analog clock configuration window**

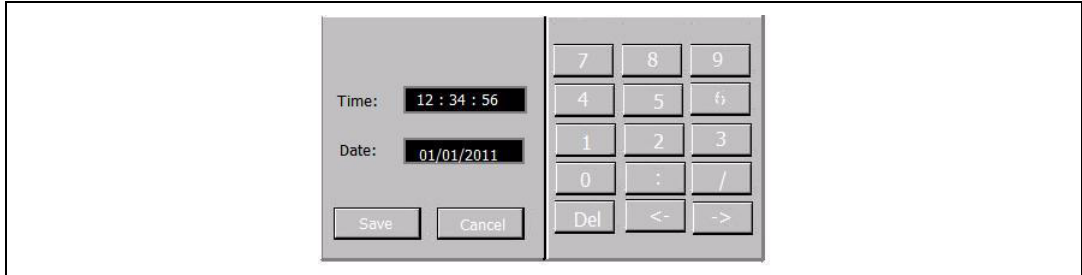

The date and the clock display use the following format.

**Figure 23. Analog clock date and time format**

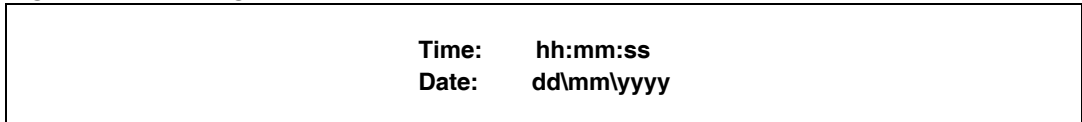

If the format is not correct, an error message ([Figure 24](#)) is displayed and the user should re-enter a valid value.

**Figure 24. Analog clock error message**

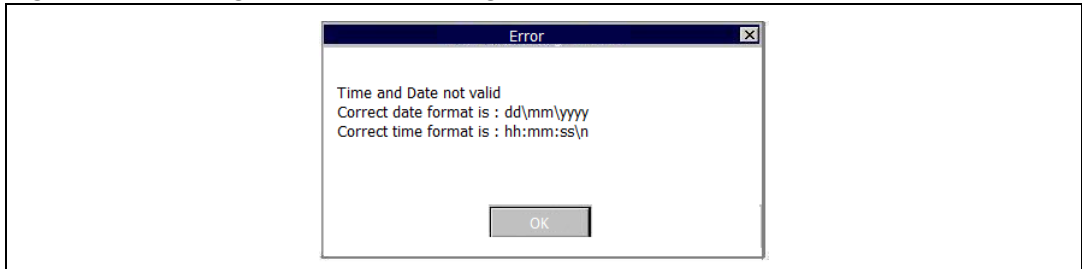

## 2.10 Camera

The camera demo obtains raw data from the camera module and displays it on the LCD through the GUI core.

**Figure 25. Camera diagram**

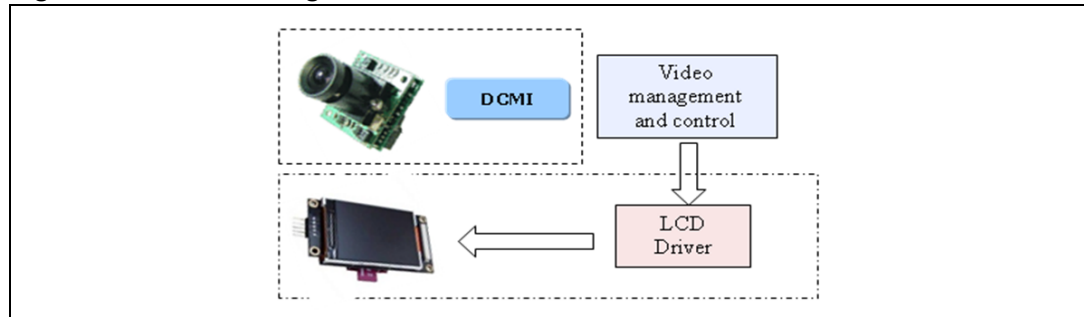

The user can use the capture button to take a snapshot of the video and display only a single frame on the LCD. Pressing again the capture button restores the continuous display mode.

**Figure 26. Capture screen**

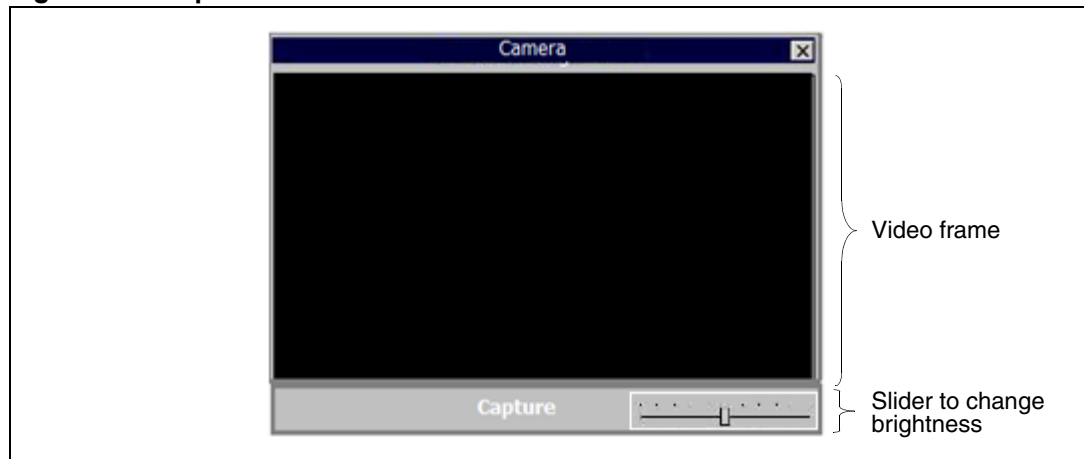

## 2.11 Sub-demo interaction

Due to the intensive CPU use of some parts of the application (GUI refresh and access to the USB Flash disk), some sub-demos cannot be run at the same time.

In order to reduce this interaction and reduce the time needed by the GUI to refresh the displayed windows, only the USB Console window and the clock are allowed to run when the Audio Player is running. This is considered as an "exclusive" sub-demo, which means that the user cannot run the Audio Player and another sub-demo at the same time. When the user attempts to launch an exclusive sub-demo, a message box is displayed to inform the user that an exclusive sub-demo is already running.

## 3 Programming the demonstration

Normally, the STM3220G-EVAL demo is included with the board and the necessary accessories described in [Section 1.2.1: Required accessories](#). However, the user can program the board by using the binary file included with the demo package (in the `\Binary` folder).

*Note:* *Demonstration binary files are provided also for the legacy STM3220F-EVAL board Rev. A. “\_vx\_y\_z” in the file name refers to the version of the demonstration firmware.*

You can program the demonstration using either the EWARM or the Bootloader method.

### Using the EWARM (v6.10 and later) preconfigured project

1. Open the `EWARM\Flash_Loader.ewd` workspace.
2. Open **Project > Download > Download file**, and select the `*.out` file to program:
  - Load the `Binary\STM3220G-EVAL_FW_vx_y_z.out` file for the STM3220G-EVAL Rev. B
  - Load the `Binary\STM3220F-EVAL_FW_vx_y_z.out` file for the STM3220F-EVAL Rev. A
3. Once the binary is programmed, remove the JTAG probe and restart the board.

### Using the Bootloader

Depending on the Bootloader serial interface you are using, you have to proceed as follows:

1. For USART or CAN interfaces:
  - a) Load the `Binary\STM3220G-EVAL_FW_vx_y_z.bin` file for the STM3220G-EVAL Rev. B
  - b) Load the `Binary\STM3220F-EVAL_FW_vx_y_z.bin` file for the STM3220F-EVAL Rev. A
2. For USB FS Device mode (DFU) interface:
  - a) Load the `Binary\STM3220G-EVAL_FW_vx_y_z.dfu` file for the STM3220G-EVAL Rev. B
  - b) Load the `Binary\STM3220F-EVAL_FW_vx_y_z.dfu` file for the STM3220F-EVAL Rev. A
3. Once the binary is programmed, configure the boot pins to the “Boot from Flash” position and restart the board.

For more information about the STM32F2xx Bootloader, please refer to AN2606, *STM32 microcontroller system memory boot mode*.

## 4 Revision history

**Table 5. Document revision history**

Date	Revision	Changes
20-Apr-2011	1	Initial release.
10-May-2011	2	Updated document for STM3220G-EVAL (Rev. B) evaluation board only.
16-Nov-2012	3	Added STM3221G-EVAL to the title and the <i>Introduction</i> . Fixed a few typos, among them a list numbering in <i>How to use the web server demonstration</i> .

**Please Read Carefully:**

Information in this document is provided solely in connection with ST products. STMicroelectronics NV and its subsidiaries ("ST") reserve the right to make changes, corrections, modifications or improvements, to this document, and the products and services described herein at any time, without notice.

All ST products are sold pursuant to ST's terms and conditions of sale.

Purchasers are solely responsible for the choice, selection and use of the ST products and services described herein, and ST assumes no liability whatsoever relating to the choice, selection or use of the ST products and services described herein.

No license, express or implied, by estoppel or otherwise, to any intellectual property rights is granted under this document. If any part of this document refers to any third party products or services it shall not be deemed a license grant by ST for the use of such third party products or services, or any intellectual property contained therein or considered as a warranty covering the use in any manner whatsoever of such third party products or services or any intellectual property contained therein.

**UNLESS OTHERWISE SET FORTH IN ST'S TERMS AND CONDITIONS OF SALE ST DISCLAIMS ANY EXPRESS OR IMPLIED WARRANTY WITH RESPECT TO THE USE AND/OR SALE OF ST PRODUCTS INCLUDING WITHOUT LIMITATION IMPLIED WARRANTIES OF MERCHANTABILITY, FITNESS FOR A PARTICULAR PURPOSE (AND THEIR EQUIVALENTS UNDER THE LAWS OF ANY JURISDICTION), OR INFRINGEMENT OF ANY PATENT, COPYRIGHT OR OTHER INTELLECTUAL PROPERTY RIGHT.**

**UNLESS EXPRESSLY APPROVED IN WRITING BY TWO AUTHORIZED ST REPRESENTATIVES, ST PRODUCTS ARE NOT RECOMMENDED, AUTHORIZED OR WARRANTED FOR USE IN MILITARY, AIR CRAFT, SPACE, LIFE SAVING, OR LIFE SUSTAINING APPLICATIONS, NOR IN PRODUCTS OR SYSTEMS WHERE FAILURE OR MALFUNCTION MAY RESULT IN PERSONAL INJURY, DEATH, OR SEVERE PROPERTY OR ENVIRONMENTAL DAMAGE. ST PRODUCTS WHICH ARE NOT SPECIFIED AS "AUTOMOTIVE GRADE" MAY ONLY BE USED IN AUTOMOTIVE APPLICATIONS AT USER'S OWN RISK.**

Resale of ST products with provisions different from the statements and/or technical features set forth in this document shall immediately void any warranty granted by ST for the ST product or service described herein and shall not create or extend in any manner whatsoever, any liability of ST.

ST and the ST logo are trademarks or registered trademarks of ST in various countries.

Information in this document supersedes and replaces all information previously supplied.

The ST logo is a registered trademark of STMicroelectronics. All other names are the property of their respective owners.

© 2012 STMicroelectronics - All rights reserved

STMicroelectronics group of companies

Australia - Belgium - Brazil - Canada - China - Czech Republic - Finland - France - Germany - Hong Kong - India - Israel - Italy - Japan - Malaysia - Malta - Morocco - Philippines - Singapore - Spain - Sweden - Switzerland - United Kingdom - United States of America

[www.st.com](http://www.st.com)

