

A guide to using the VL53L5CX multizone Time-of-Flight ranging sensor with a wide field of view ultra lite driver (ULD)

Introduction

The purpose of this user manual is to explain how to handle the VL53L5CX Time-of-Flight (ToF) sensor, using the ultra lite driver (ULD) API. It describes the main functions to program the device, the calibrations, and the output results.

The VL53L5CX is a state of the art, ToF, multizone ranging sensor enhancing the STMicroelectronics FlightSense product family. Housed in a miniature reflowable package, it integrates a SPAD array, physical infrared filters, and diffractive optical elements (DOE) to achieve the best ranging performance in various ambient lighting conditions with a range of cover glass materials.

Multizone distance measurements are possible up to 8x8 zones with a wide 63° diagonal field of view (FoV) which can be reduced by software. Each zone of the VL53L5CX measures the distance of the target up to 4 meters, at a maximum frequency of 60 Hz.

Thanks to STMicroelectronics patented histogram algorithms, the VL53L5CX is able to detect different objects within the FoV. The histogram also provides immunity to cover glass crosstalk beyond 60 cm.

Figure 1. VL53L5CX sensor module

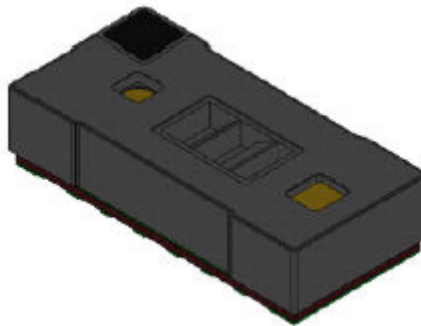

References

VL53L5CX datasheet (DS13754).

1 Acronyms and abbreviations

Acronym/abbreviation	Definition
DOE	diffractive optical element
FoV	field of view
I ² C	inter-integrated circuit (serial bus)
Kcps/SPAD	Kilo-count per second per spad (unit used to quantify the number of photons into the SPAD array)
RAM	random-access memory
SCL	serial clock line
SDA	serial data
SPAD	single photon avalanche diode
ToF	Time-of-Flight
ULD	ultra lite driver
VCSEL	vertical cavity surface emitting diode
VHV	very high voltage
Xtalk	crosstalk

2 Functional description

2.1 System overview

The VL53L5CX system is composed of a hardware module and the ultra lite driver software (VL53L5CX ULD) running on a host (see figure below). The hardware module contains the ToF sensor. STMicroelectronics delivers the software driver, which is referred to in this document as "the driver". This document describes the functions of the driver, which are accessible to the host. These functions control the sensor and get the ranging data.

Figure 2. VL53L5CX system overview

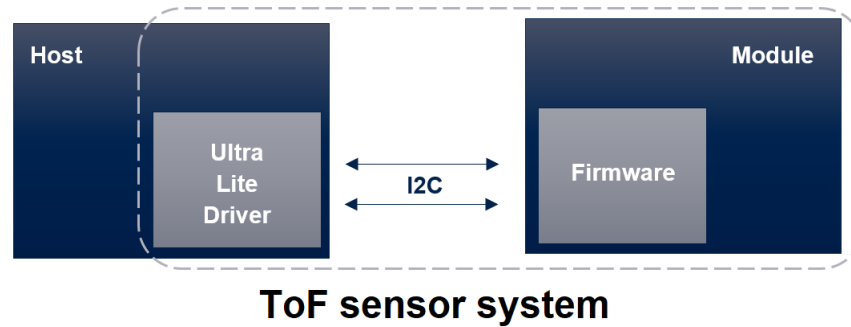

2.2 Effective orientation

The module includes a lens over the Rx aperture, which flips (horizontally and vertically) the captured image of the target. Consequently, the zone identified as zone 0, in the bottom left of the SPAD array, is illuminated by a target located at the top right-hand side of the scene.

Figure 3. VL53L5CX effective orientation

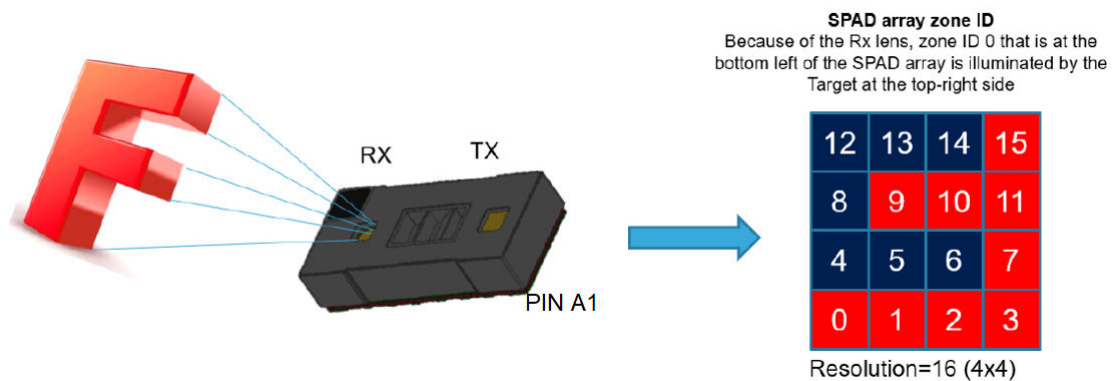

2.3 Schematics and I²C configuration

The communication between driver and firmware is handled by I²C, with a capability of operating up to 1 MHz. The implementation requires pull-ups on the SCL and SDA lines. Refer to the VL53L5CX datasheet for more information.

The VL53L5CX device has a default I²C address of 0x52. However, it is possible to change the default address to avoid conflicts with other devices, or facilitate adding multiple VL53L5CX modules to the system for a greater system FoV. The I²C address can be changed using the `vl53l5cx_set_i2c_address()` function.

Figure 4. Multiple sensors on I²C bus

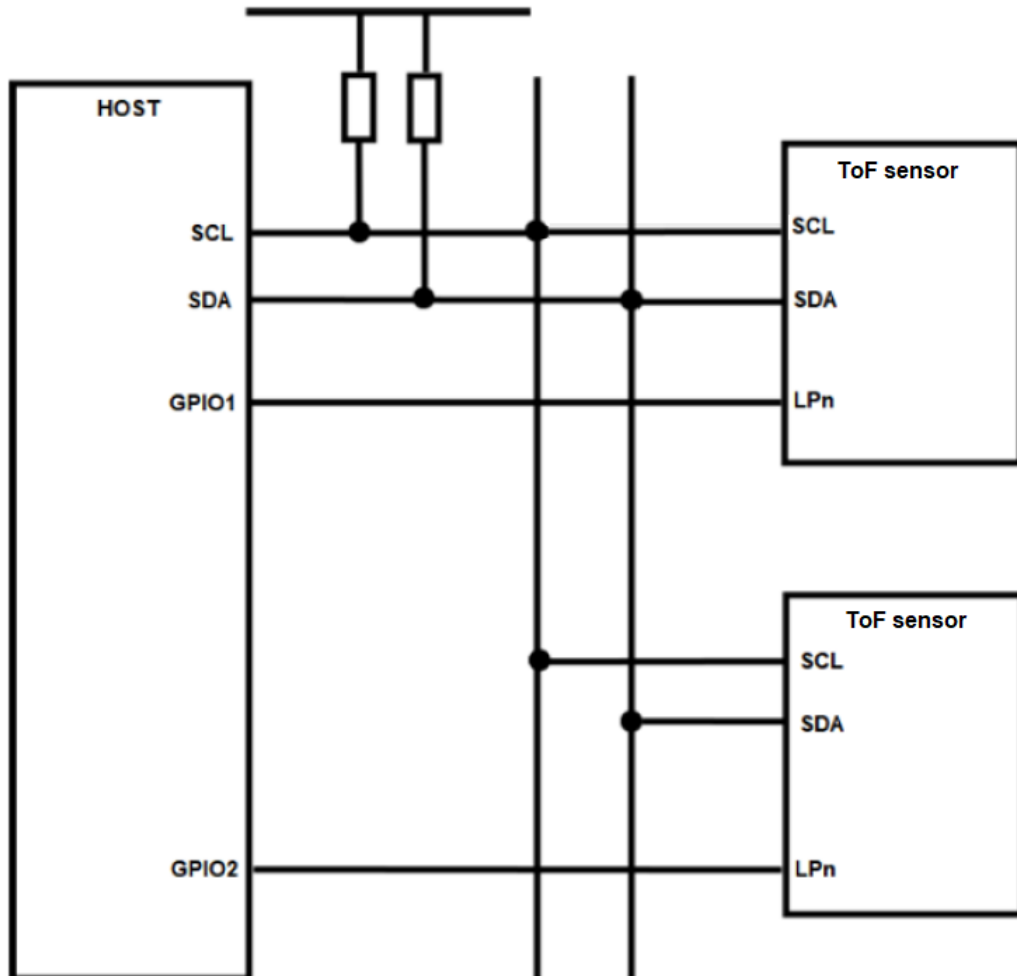

To allow a device to have its I²C address changed without affecting others on the I²C bus, it is important to disable the I²C communication of the devices not being changed. The procedure is the following one:

1. Power up the system as normal.
2. Pull down the LPn pin of the device that will not have its address changed.
3. Pull up the LPn pin of the device that has the I²C address changed.
4. Program the I²C address to the device using the function `set_i2c_address()` function.
5. Pull up the LPn pin of the device not being reprogrammed.

All devices should now be available on the I²C bus. Repeat the above steps for all the VL53L5CX devices in the system that require a new I²C address.

3 Package content and data flow

3.1 Driver architecture and content

The VL53L5CX ULD package is composed of four folders. The driver is located in the folder / VL53L5CX_ULD_API.

The driver is composed of mandatory and optional files. Optional files are plugins used to extend ULD features. Each plugin starts with the word "vl53l5cx_plugin" (e.g vl53l5cx_plugin_xtalk.h). If the user does not want the proposed plugins, they can be removed without impacting the other driver features. The following figure represents the mandatory files and the optional plugins.

Figure 5. Driver architecture

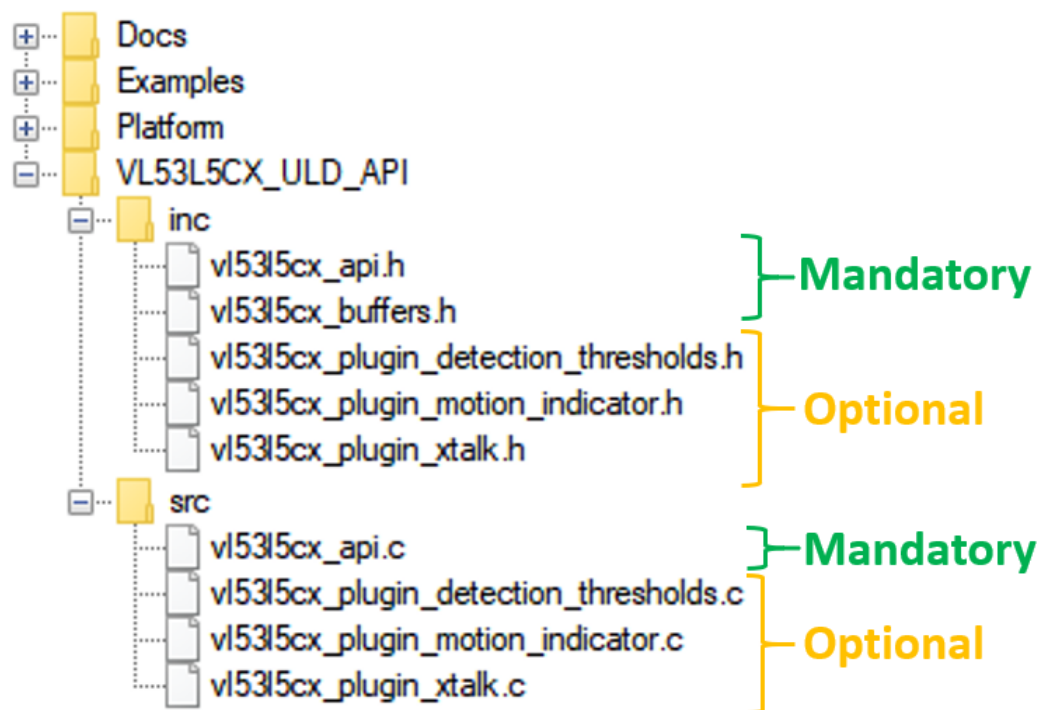

The user also needs to implement two files located in the /Platform folder. The proposed platform is an empty shell, and must be filled with dedicated functions.

Note: Platform.h file contains mandatory macros to use the ULD. All the file content is mandatory to correctly use the ULD.

3.2 Calibration flow

Crosstalk (Xtalk) is defined as the amount of signal received on the SPAD array, which is due to VCSEL light reflection inside the protective window (cover glass) added on top of the module. The VL53L5CX module is self-calibrated, and can be used without any additional calibration.

Crosstalk calibration may be required if the module is protected by a cover glass. The VL53L5CX is immune to crosstalk beyond 60 cm thanks to a histogram algorithm. However, at short distances below 60 cm, Xtalk can be larger than the actual returned signal. This gives a false target reading or makes targets appear closer than they really are. All crosstalk calibration functions are included in a Xtalk plugin (optional). The user needs to use the file 'vl53l5cx_plugin_xtalk'.

The crosstalk can be calibrated once, and data can be saved so it can be reused later. A target at a fixed distance, with a known reflectance is required. The minimum distance required is 600 mm, and the target must cover the whole FoV. Depending on the setup, the user can modify settings to adapt the crosstalk calibration, as proposed in the following table.

Table 1. Available settings for calibration

Setting	Min	Proposed by STMicroelectronics	Max
Distance [mm]	600	600	3000
Number of samples	1	4	16
Reflectance [%]	1	3	99

Note: Increasing the number of samples increases the accuracy, but it also increases the time for calibration. The time relative to the number of samples is linear, and values follow the approximate timeout:

- 1 sample ≈ 1 second
- 4 samples ≈ 2.5 seconds
- 16 samples ≈ 8.5 seconds

The calibration is performed using the function `vl53l5cx_calibrate_xtalk()`. This function can be used at any time. However, the sensor must be initialized first. The following figure represents the crosstalk calibration flow.

Figure 6. Crosstalk calibration flow

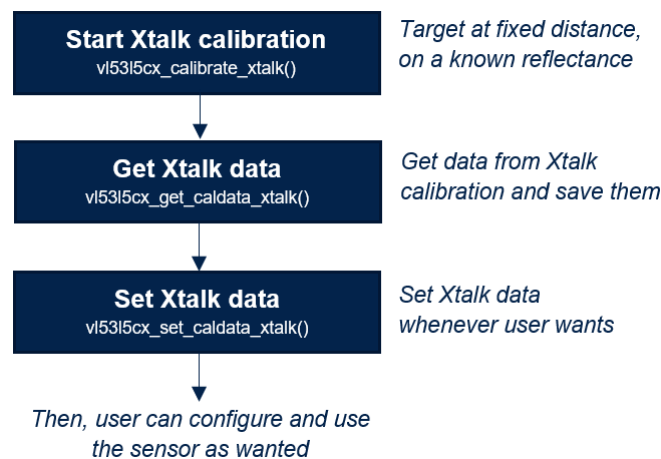

3.3 Ranging flow

The following figure represents the ranging flow used to get measurements. Xtalk calibration and optional function calls must be used before starting the ranging session. The get/set functions cannot be used during a ranging session, and 'on-the-fly' programming is not supported.

Figure 7. Ranging flow using VL53L5CX

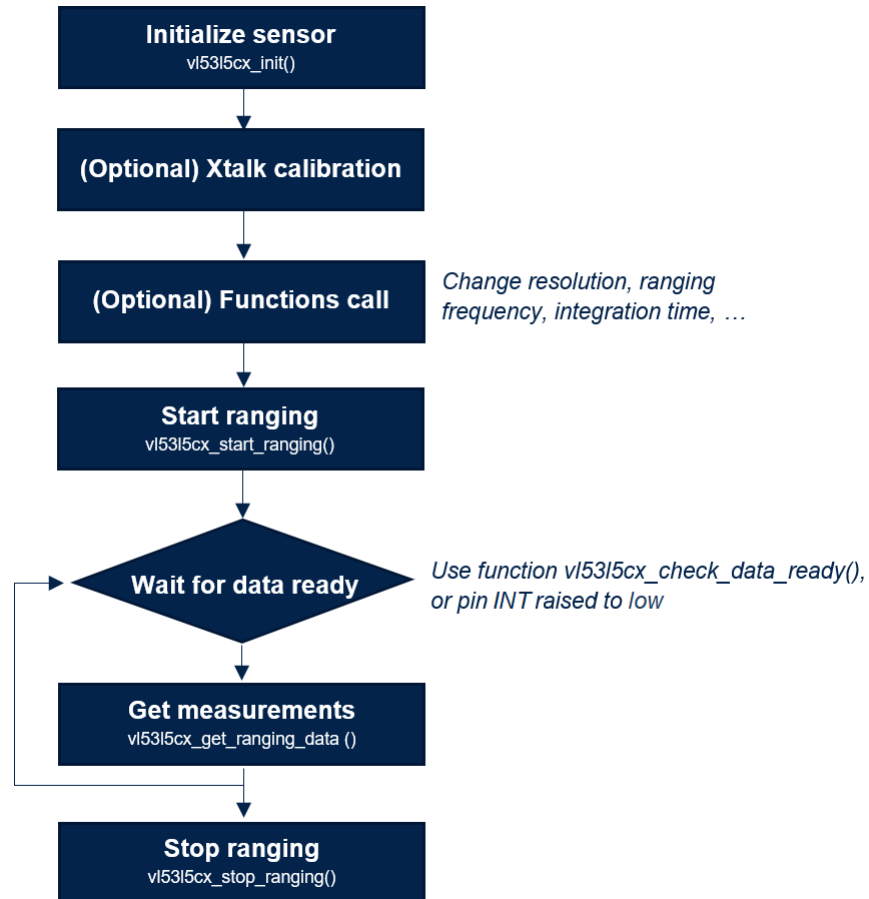

4 Available features

The VL53L5CX ULD API includes several functions, which allow the user to tune the sensor, depending on the use case. All the functions available for the driver are described in the following sections.

4.1 Initialization

Initialization must be done before using the VL53L5CX sensor. This operation requires the user to:

1. Power on the sensor (VDDIO, AVDD, LPn pins set to High, and pin I2C_RST set to 0)
2. Call the function `vl53l5cx_init()`. The function copies the firmware (~84 Kbytes) to the module. This is done by loading the code over the I²C interface, and performing a boot routine to complete the initialization.

4.2 Sensor reset management

To reset the device, the following pins need to be toggled:

1. Set pins VDDIO, AVDD, and LPn to low.
2. Wait 10 ms.
3. Set pins VDDIO, AVDD, and LPn to high.

Note: Reset the I²C communication by toggling the I2C_RST pin.

4.3 Resolution

The resolution corresponds to the number of available zones. The VL53L5CX sensor has two possible resolutions: 4x4 (16 zones) and 8x8 (64 zones). By default the sensor is programmed in 4x4.

The function `vl53l5cx_set_resolution()` allows the user to change the resolution. As the ranging frequency depends on the resolution, this function must be used before updating the ranging frequency. Moreover, changing the resolution also increases the traffic size on the I²C bus when the results are read.

4.4 Ranging frequency

Ranging frequency can be used to change the measurement frequency. As the maximum frequency is different between 4x4 and 8x8 resolutions, use this functionality after choosing a resolution. The minimum and maximum allowed values are listed in the following table.

Table 2. Minimum and maximum ranging frequencies

Resolution	Min ranging frequency [Hz]	Max ranging frequency [Hz]
4x4	1	60
8x8	1	15

Ranging frequency can be updated using the function `vl53l5cx_set_ranging_frequency_hz()`. By default, the ranging frequency is set to 1 Hz.

4.5 Ranging mode

Ranging mode allows the user to choose between ranging in high performance or low power consumption.

There are two modes proposed:

- **Continuous:** The device continuously grabs frames with a ranging frequency defined by user. The VCSEL is enabled during all ranging, so maximum ranging distance and ambient immunity are better. This mode is advised for fast ranging measurements or high performances.
- **Autonomous:** This is the default mode. The device continuously grabs frames with a ranging frequency defined by the user. The VCSEL is enabled during a period defined by the user, using function `vl53l5cx_set_integration_time_ms()`. As the VCSEL is not always enabled, the power consumption is reduced. The benefits are more obvious with a reduced ranging frequency. This mode is advised for low power applications.

The ranging mode can be changed using function `vl53l5cx_set_ranging_mode()`.

Note: In autonomous mode, the frame period of the first frame can be shorter than the ranging period set by the user.

4.6 Integration time

Integration time is a feature only available using the autonomous ranging mode (refer to [Section 4.5: Ranging mode](#)). It allows the user to change the time while VCSEL is enabled. Changing integration time if the ranging mode is set to continuous has no effect. The default integration time is set to 5 ms.

The effect of integration time is different for 4x4 and 8x8 resolutions. Resolution 4x4 is composed of one integration time, and 8x8 resolution is composed of four integration times. The following figures represent the VCSEL emission for both resolutions.

Figure 8. Integration time for 4x4 autonomous

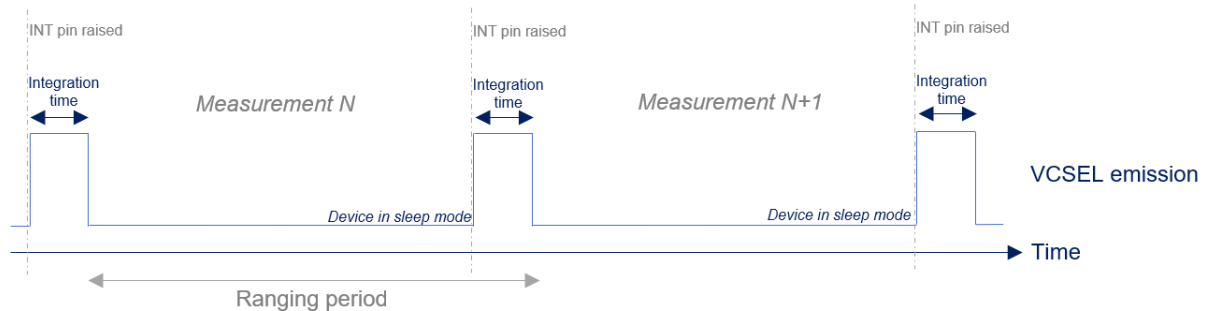
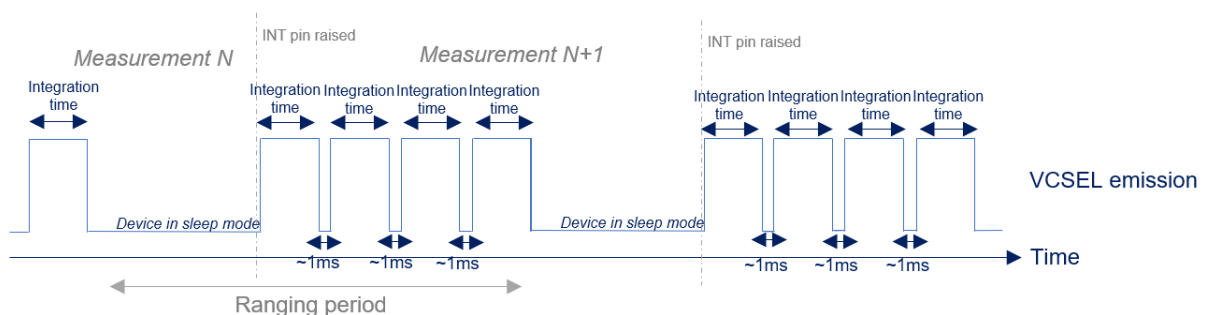

Figure 9. Integration time for 8x8 autonomous



The sum of all integration times + 1 ms overhead must be lower than the measurement period. Otherwise, the ranging period is automatically increased.

4.7 Power modes

Power modes can be used to reduce the power consumption when the device is not used. The VL53L5CX can operate in one of the following power modes:

- Wake-up: The device is set in HP idle (high power), waiting for instructions.
- Sleep: The device is set in LP idle (low power), the low power state. The device cannot be used until set in wake-up mode. This mode retains the firmware and the configuration.

The power mode can be changed using the function `vl53l5cx_set_power_mode()`. The default mode is wake-up.

Note: If the user wants to change the power mode, the device must not be in a ranging state.

4.8 Sharpener

The signal returned from a target is not a clean pulse with sharp edges. The edges slope away and may affect the distances reported in adjacent zones. The sharpener is used to remove some or all of the signal caused by a veiling glare.

The example shown in the following figure represents a close target at 100 mm centered in the FoV, and another target, further behind at 500 mm. Depending on the sharpener value, the close target may appear in more zones than the real one.

Figure 10. Example of scene using several sharpener values

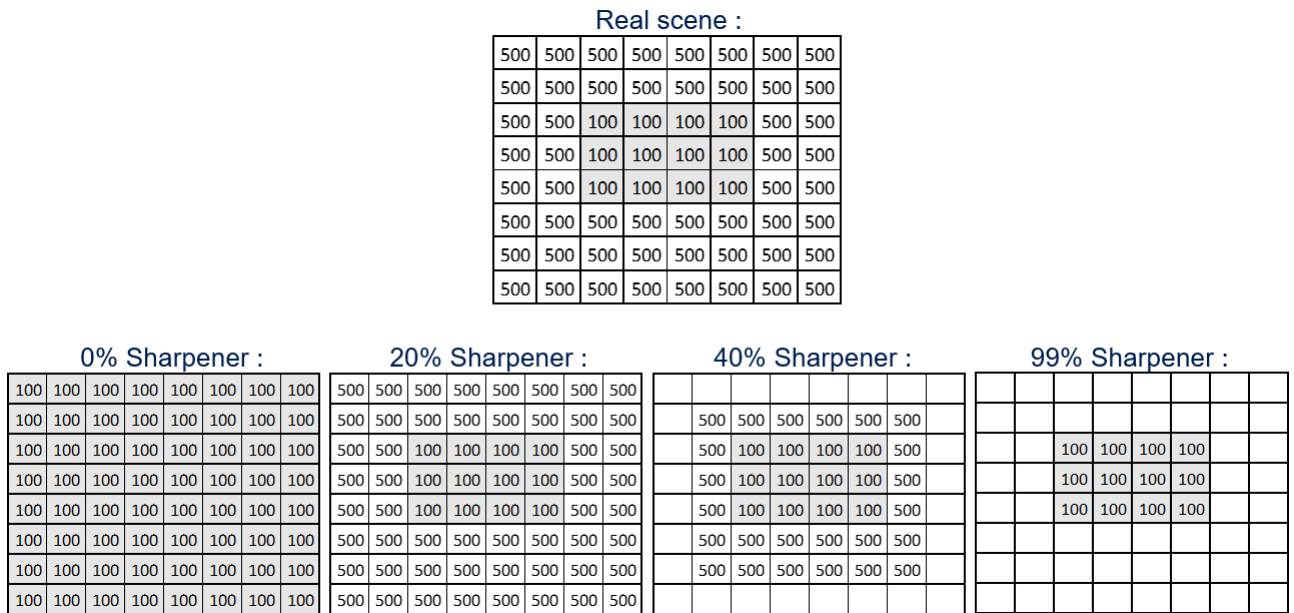

Sharpener can be changed using the function `vl53l5cx_set_sharpener_percent()`. The allowed values are between 0% and 99%. The default value is 5%.

4.9 Target order

The VL53L5CX can measure several targets per zone. Thanks to the histogram processing, the host is able to choose the order of reported targets. There are two options:

- Closest: The closest target is the first reported
- Strongest: The strongest target is the first reported

The target order can be changed using the function `vl53l5cx_set_target_order()`. The default order is Strongest.

The example in the following figure represents the detection of two targets. One at 100 mm with a low reflectance, and one at 700 mm with a high reflectance.

Figure 11. Example of histogram with two targets

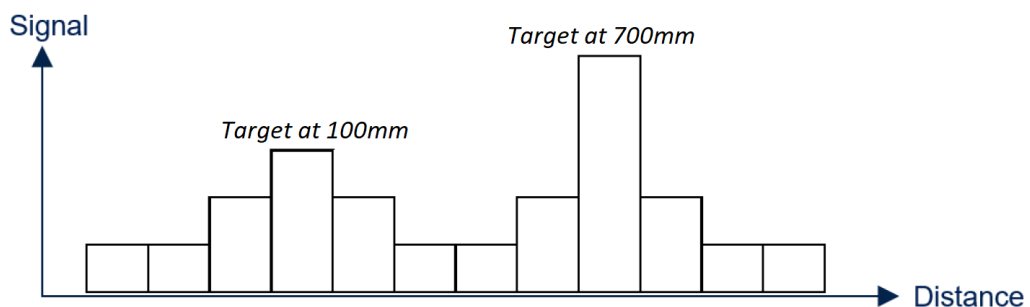

4.10 Multiple targets per zone

The VL53L5CX can measure up to four targets per zone. The user can configure the number of targets returned by the sensor.

Note: The minimum distance between two targets to be detected is 600 mm.

The selection is not possible from the driver; it has to be done in the 'platform.h' file. The macro `VL53L5CX_NB_TARGET_PER_ZONE` needs to be set to a value between 1 and 4. The target order described in [Section 4.9: Target order](#) directly impacts the order of detected target. By default, the sensor only outputs a maximum of one target per zone.

Note: An increased number of targets per zone increases the required RAM size.

4.11 Xtalk margin

The Xtalk margin is an additional feature only available using the plugin Xtalk. The .c and .f files 'vl53l5cx_plugin_xtalk' need to be used.

The margin is used to change the detection threshold when a cover glass is present on the top of the sensor. The threshold can be increased to ensure that the cover glass is never detected, after setting crosstalk calibration data. For example, the user can run a crosstalk calibration on one single device, and reuse the same calibration data for all other devices. The Xtalk margin can be used to tune the crosstalk correction. The figure below represents the Xtalk margin.

Figure 12. Xtalk margin

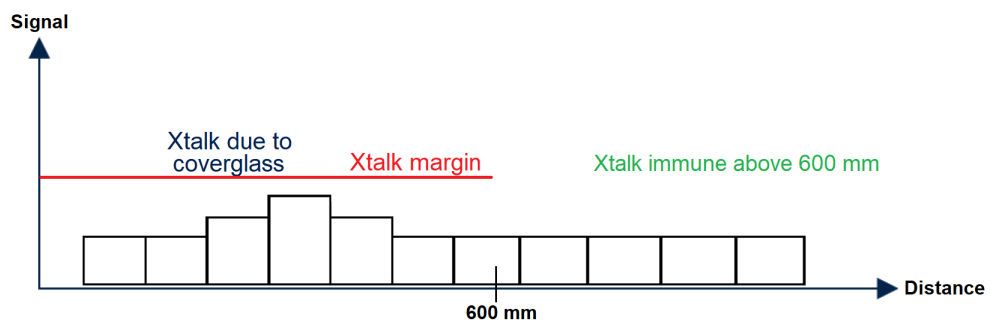

4.12 Detection thresholds

In addition to the regular ranging capabilities, the sensor can be programmed to detect an object under certain predefined criteria. This feature is available using the plugin "detection thresholds", which is an option not included by default in the API. The files called 'vl53l5cx_plugin_detection_thresholds' need to be used.

The feature can be used to trigger an interrupt to pin A3 (INT) when conditions defined by the user are met. There are three possible configurations:

- Resolution 4x4: using one threshold per zone (a total of 16 thresholds)
- Resolution 4x4: using two thresholds per zone (a total of 32 thresholds)
- Resolution 8x8: using one threshold per zone (a total of 64 thresholds)

Whatever the configuration used, the procedure for creating thresholds and the RAM size are the same. For each threshold combination, several fields need to be filled:

- Zone id: id of the selected zone (refer to [Section 2.2: Effective orientation](#))
- Measurement: measurement to catch (distance, signal, number of SPADs, ...)
- Type: windows of measurements (in windows, out of windows, below low threshold, ...)
- Low threshold: low threshold user for trigger. User does not need to set the format, it is automatically handled by the API.
- High threshold: high threshold user for trigger. The user does not need to set the format; it is automatically handled by the API.
- Mathematic operation: only used for 4x4 – 2 threshold combinations per zone. The user can set a combination using several thresholds in one zone.

4.13 Motion indicator

The VL53L5CX sensor has an embedded firmware feature allowing motion detection in a scene. The motion indicator is computed between sequential frames. This option is available using the plugin 'vl53l5cx_plugin_motion_indicator'.

The motion indicator is initialized using the vl53l5cx_motion_indicator_init() function. To change the sensor resolution, update the motion indicator resolution using the dedicated function: vl53l5cx_motion_indicator_set_resolution().

The user may also change the minimum and maximum distances for detecting motion. The difference between the minimum and maximum distances cannot be greater than 1500 mm. By default, distances are initialized with values between 400 mm and 1500 mm.

Results are stored in the field 'motion_indicator'. In this field, the array 'motion' gives a value containing the motion intensity per zone. A high value indicates high motion variation between frames. A typical movement gives a value between 100 and 500. This sensitivity depends on the integration time, target distance, and target reflectance.

An ideal combination for low power applications is the use of the motion indicator with autonomous ranging mode, and detection thresholds programmed on the motion. This allows detection of movement variations in the FoV with minimum power consumption.

4.14 Periodic temperature compensation

The ranging performance is affected by temperature variations. The VL53L5CX sensor embeds a temperature compensation that is calibrated once when streaming starts. However, if the temperature evolves, the compensation may not be aligned with the new temperature. To avoid this issue, the customer can run a periodic temperature compensation by using an auto VHV. The periodic temperature calibration takes a few milliseconds to run. The user can define the period.

To use this feature, the customer needs to:

- Call the function vl53l5cx_set_VHV_repeat_count().
- Then, give the number of frames between every new calibration as the argument.

If the argument is 0, the compensation is disabled.

5 Ranging results

5.1 Available data

An extensive list of target and environment data may be output during ranging activities. The following table describes the parameters available to the user.

Table 3. Available output using VL53L5CX sensor

Element	Nb bytes (RAM)	Unit	Description
Ambient per SPAD	256	Kcps/SPAD	Ambient rate measurement performed on the SPAD array, with no active photon emission, to measure the ambient signal rate due to noise.
Number of targets detected	64	None	Number of detected targets in the current zone. This value should be the first one to check to know a measurement validity.
Number of SPADs enabled	256	None	Number of SPADs enabled for the current measurement. A far or low reflective target activates more SPADs.
Signal per SPAD	256 x nb targets programmed	Kcps/SPAD	Quantity of photons measured during the VCSEL pulse.
Range sigma	128 x nb targets programmed	Millimeter	Sigma estimator for the noise in the reported target distance.
Distance	128 x nb targets programmed	Millimeter	Target distance
Target status	64 x nb targets programmed	None	Measurements validity. See Section 5.5: Results interpretation for more information.
Reflectance	64 x number targets programmed	Percent	Estimated target reflectance in percent
Motion indicator	140	None	Structure containing the motion indicator results. The field 'motion' contains the motion intensity.

Note: For several elements (signal per spad, sigma, ...) access to data is different if the user has programmed more than one target per zone (see [Section 4.10: Multiple targets per zone](#)). See example codes for more information.

5.2 Customize output selection

By default, all VL53L5CX outputs are enabled. If needed, the user can disable some sensor outputs.

Disabling measurements is not available on the driver; it must be performed in the 'platform.h' file. The user can declare the following macros to disable outputs:

```
#define VL53L5CX_DISABLE_AMBIENT_PER_SPAD
#define VL53L5CX_DISABLE_NB_SPADS_ENABLED
#define VL53L5CX_DISABLE_NB_TARGET_DETECTED
#define VL53L5CX_DISABLE_SIGNAL_PER_SPAD
#define VL53L5CX_DISABLE_RANGE_SIGMA_MM
#define VL53L5CX_DISABLE_DISTANCE_MM
#define VL53L5CX_DISABLE_TARGET_STATUS
#define VL53L5CX_DISABLE_REFLECTANCE_PERCENT
#define VL53L5CX_DISABLE_MOTION_INDICATOR
```

Consequently, the fields are not declared in the results structure, and the data is not transferred to the host. The RAM size and I²C size are reduced.

To ensure data consistency, ST always recommends keeping the 'number of targets detected' and 'target status' enabled. This filters the measurements depending on the target status (refer to [Section 5.5: Results interpretation](#)).

5.3 Getting ranging results

During the ranging session, there are two ways to know if new ranging data is available:

- Polling mode: Continuously uses function `vl53l5cx_check_data_ready()`. It detects a new stream count returned by the sensor.
- Interrupt mode: Waits for an interrupt raised on pin A3 (GPIO1). The interrupt is automatically cleared after ~100 μ s.

When new data is ready, the results can be read using function `vl53l5cx_get_ranging_data()`. It returns an updated structure containing all selected output. As the device is asynchronous, there is no interrupt to clear to continue the ranging session.

This feature is available for both continuous and autonomous ranging modes.

5.4 Using raw firmware format

After transferring the ranging data through the I²C, there is a conversion between the firmware format and the host format. This operation is typically performed to have a ranging distance in millimeters as a default output of the sensor. If the user wants to use the firmware format, the following macro must be defined in the platform file: VL53L5CX

```
#define VL53L5CX_USE_RAW_FORMAT
```

5.5 Results interpretation

The data returned by the VL53L5CX can be filtered to take into account the target status. The status indicates the measurement validity. The full status list is described in the following table.

Table 4. List of available target status

Target status	Description
0	Ranging data are not updated
1	Signal rate too low on SPAD array
2	Target phase
3	Sigma estimator too high
4	Target consistency failed
5	Range valid
6	Wrap around not performed (typically the first range)
7	Rate consistency failed
8	Signal rate too low for the current target
9	Range valid with large pulse (may be due to a merged target)
10	Range valid, but no target detected at previous range
11	Measurement consistency failed
12	Target blurred by another one, due to sharpener
13	Target detected but inconsistent data. Frequently happens for secondary targets.
255	No target detected (only if number of targets detected is enabled)

To have consistent data, the user needs to filter invalid target status. To give a confidence rating, a target with status 5 is considered as 100% valid. A status of 6 or 9 can be considered with a confidence value of 50%. All other statuses are below the 50% confidence level.

5.6 Driver errors

When an error occurs using the VL53L5CX sensor, the driver returns a specific error. The following table lists the possible errors.

Table 5. List of errors available using the driver

Target status	Description
0	No error
127	The user programmed an incorrect setting (unknown resolution, ranging frequency too high, ...)
255	Major error. Usually a timeout error, due to an I ² C error.
other	Combination of multiple errors described above

Note: The host can implement more error codes by using the platform files.

Revision history

Table 6. Document revision history

Date	Version	Changes
21-Jun-2021	1	Initial release
30-Aug-2021	2	Added Section 5.4: Using raw firmware format Added new target status 13 in Table 4. List of available target status
05-Sep-2022	3	Added note about minimum minimum distance between targets to Section 4.10: Multiple targets per zone
10-Aug-2023	4	Modified Figure 11. Example of histogram with two targets
21-Feb-2024	5	Added VHV (very high voltage) to Section 1: Acronyms and abbreviations . Added Section 4.14: Periodic temperature compensation
28-Oct-2024	6	Section 4.5: Ranging mode : Added a note about the frame period of the first frame.

Contents

1	Acronyms and abbreviations	2
2	Functional description	3
2.1	System overview	3
2.2	Effective orientation	3
2.3	Schematics and I ² C configuration	4
3	Package content and data flow	5
3.1	Driver architecture and content	5
3.2	Calibration flow	6
3.3	Ranging flow	7
4	Available features	8
4.1	Initialization	8
4.2	Sensor reset management	8
4.3	Resolution	8
4.4	Ranging frequency	8
4.5	Ranging mode	9
4.6	Integration time	9
4.7	Power modes	10
4.8	Sharpener	10
4.9	Target order	11
4.10	Multiple targets per zone	11
4.11	Xtalk margin	11
4.12	Detection thresholds	12
4.13	Motion indicator	12
4.14	Periodic temperature compensation	12
5	Ranging results	13
5.1	Available data	13
5.2	Customize output selection	13
5.3	Getting ranging results	14
5.4	Using raw firmware format	14
5.5	Results interpretation	14
5.6	Driver errors	15
	Revision history	16

IMPORTANT NOTICE – READ CAREFULLY

STMicroelectronics NV and its subsidiaries (“ST”) reserve the right to make changes, corrections, enhancements, modifications, and improvements to ST products and/or to this document at any time without notice. Purchasers should obtain the latest relevant information on ST products before placing orders. ST products are sold pursuant to ST’s terms and conditions of sale in place at the time of order acknowledgment.

Purchasers are solely responsible for the choice, selection, and use of ST products and ST assumes no liability for application assistance or the design of purchasers’ products.

No license, express or implied, to any intellectual property right is granted by ST herein.

Resale of ST products with provisions different from the information set forth herein shall void any warranty granted by ST for such product.

ST and the ST logo are trademarks of ST. For additional information about ST trademarks, refer to www.st.com/trademarks. All other product or service names are the property of their respective owners.

Information in this document supersedes and replaces information previously supplied in any prior versions of this document.

© 2024 STMicroelectronics – All rights reserved